

TECHNICAL LUMINAIRES 2024





WHO WE ARE

Artificial light enhances the way we live and work. It brings us safety, comfort and productivity. Originated in Germany, MEGAMAN® is committed to providing light in a way that is truly sustainable, energy saving and of such a quality that it brings a positive difference into the lives of all who use our innovative LED lighting solutions.

MEGAMAN® is proud to be a major lighting brand to have exclusively manufactured low-energy lighting products throughout its entire history, offering more than 25 years of industry expertise and innovation to the lighting market.

Beginning in 1994 with the highly successful production of CFL light sources, MEGAMAN® has evolved to become a complete low-energy LED lighting solutions provider. MEGAMAN® has built a reputation for producing high-performance LED light sources that offer a true replacement for traditional metal halide and halogen – combining quality lighting performance with substantial energy savings.

MEGAMAN® is now applying its market-leading experience to an even wider range of lighting solutions including revolutionary Smart Lighting System and a suite of integrated LED luminaires.

- *INGENIUM*® ZB Smart Lighting Solution provides further energy saving potential for users and allows them have full control of smart devices via mobile app from anywhere in the world
- An extensive range of LED Luminaires are developed for both indoor and outdoor applications across diverse industries
- MEGAMAN®'s lighting products are distributed throughout the world mainly in Europe, Middle East and Asia
- Our advanced Research and Development facilities will ensure a continuous supply of innovative and sustainable lighting products in the market.

MEGAMAN® continues to play a leading role in combating climate change and carbon emissions by pursuing continuous innovation in the production of low-energy lighting solutions.

MEGAMAN® MILESTONES

- 2023 Launched *INGENIUM*® MATTER smart lighting, works with various platforms
- 2022 Infinite IoT lighting solution developed based on Bluetooth Low Energy which is widely adopted in smartphones and tablets
- 2019 Extended product range of *INGENIUM*® ZB smart lighting released
- 2018 Launched Dual Beam Technology (DBT) which empowers users to have two beam angles in one LED luminaire or lamp
- 2016 Launched U-DIM™ technology which offers seamless dimming and is compatible with the widest range of existing dimmers
- 2015 Being one of the first companies to use plastic extrusion to produce water-proof battens; Launched *INGENIUM*® ZB smart lighting solution which adopts Zigbee technology
- 2014 Launched first smart lighting range, *INGENIUM*® BLU; Industry first full range of Dim to Warm LED products
- 2013 Integrated LED luminaires introduced
- 2012 Patented LED module and light engine - *TECOH*® MHx and *TECOH*® CFx
TECOH® CFx - World's first 2000lm Zhaga Book2 Certified Light Engine
- 2011 High R9 Technology first introduced to LED range
- 2010 Launched the first *MEGAMAN*® LED Candle and Classic Lamp
- 2009 Innovative Thermal Conductive Highway™ (TCH) technology incorporated into *MEGAMAN*® LED reflectors
- 2008 Revolutionary patents and technologies invented for CFL products including: Patented Cooling-Tube technology, Silicone Protection technology, Award-winning industry first CFL GU10 reflector, Industry first Long Life CFL reaches 15,000 hours lifetime, Dimmable CFLs using DorS Step Dimming and DIMMERABLE Linear Dimming technology, Amalgam technology which prevents the use of liquid mercury.
- 1999
- 1997 Industry first candle-shaped CFL launched
- 1996 Industry first classic-shaped CFL launched
- 1994 *MEGAMAN*® incorporated in Germany



Rigorous Quality and Management Systems

All MEGAMAN® products are designed, tested and produced in our own factories in Xiamen, China. Standards have been implemented factory-wide to ensure the MEGAMAN® manufacturing processes deliver innovative, reliable and safe products with high-quality standards now and in the future.

To ensure that MEGAMAN® products comply with the highest quality standards, company manufacturing plants are equipped with their own assembly lines.

The MEGAMAN® business runs under the most stringent management and quality systems. The green elements of the production process are maximised, employee welfare is prioritised and the company is socially responsible to the local community. To continually develop these areas, MEGAMAN® has undertaken a range of international accreditations. These include:

Quality Management System

MEGAMAN® lamps and luminaires are manufactured and certified to ISO 9001:2015.

Product Quality Assurance

MEGAMAN® lamps and luminaires are made using premium quality materials and innovative technologies within stringent control measures, to deliver maximum performance and energy efficiencies.

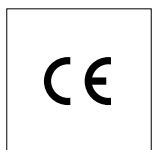

Innovative and Unique Products

With our patented LED design and technology, the MEGAMAN® LED luminaires and lamps are able to deliver superb performance, including low power consumption, excellent light output and low maintenance costs. They provide the highest quality lighting performance of any LED-based product on the market consuming the same power!

Entering a New Era in LED Lighting and Luminaire Solutions

Unique Features

- Energy efficient replacement for traditional metal halide, CFL, halogen and incandescent luminaires
- Deliver superb lighting performance
- High luminous efficacy up to 109lm/W
- High lumen maintenance: rated lumen maintenance of 70% (L70) at up to 50,000 hours life
- High colour rendering up to Ra97
- High colour temperature consistency
- Long rated life up to 50,000 hours
- Simple installation and servicing
- High energy savings
- No UV and IR radiation

Additional Benefits

- Mercury-free
- Instant start-up
- Wide range of operating temperatures

Applications

- Hospitality
- Retail lighting
- Office
- Residential
- Decorative
- Industrial
- Outdoor

CONTENT

ABOUT MEGAMAN®

Who We Are	3	Rigorous Quality and Management Systems	5
MEGAMAN® Milestones	4	Innovative and Unique Products	5



Indoor / Bulkhead



MEGAMAN®
RENZO
Standby Dim
10



MEGAMAN®
RENZO
16



MEGAMAN®
JOSIE
26



MEGAMAN®
AATOS
30



MEGAMAN®
AATOS
STARRY
34



MEGAMAN®
KATIA
38



MEGAMAN®
RENZOLITE
42

Indoor / Downlight



MEGAMAN®
MILENA
PRO
44



MEGAMAN®
MILENA
48



MEGAMAN®
RICO HR
56



MEGAMAN®
TEGO
60



MEGAMAN®
TEGO 2
62



MEGAMAN®
TEGO 2 FRD
64



MEGAMAN®
TEGO 3
66



MEGAMAN®
TEGO SLIM
68



MEGAMAN®
KANA
70



MEGAMAN®
PLANEX
74



MEGAMAN®
MILENALITE
78



MEGAMAN®
KAYLA
84



Indoor / High Bay



MEGAMAN®
GEO 3
88



MEGAMAN®
KEO 2
94



Indoor / Batten



MEGAMAN®
TONO 2
 98



MEGAMAN®
FARRON
 102



MEGAMAN®
NARDOS 2
 110



MEGAMAN®
GARRON
 114

Indoor / Linear Profile



MEGAMAN®
GABIO 2
 106



MEGAMAN®
PINOLITE 2
 118



MEGAMAN®
FORD
 124



MEGAMAN®
MILO
 126

Indoor / Panel



MEGAMAN®
BERTO SIDELIT
 130



MEGAMAN®
ESTELA 2
 134



MEGAMAN®
BERTO BACKLIT
 138

Indoor / Track Panel



MEGAMAN®
XAVIER
 142

Indoor / Track Lighting



MEGAMAN®
MARCO 2 Mini
 148



MEGAMAN®
MARCO 2 Midi
 149



MEGAMAN®
MARCO 2 90
 150



MEGAMAN®
MORA
 152



MEGAMAN®
MOSAIC
 154



MEGAMAN®
TOBY
 156

Indoor / Trunking



MEGAMAN®
TRAVIS
 158

CONTENT



Indoor / Under Cabinet



MEGAMAN®
KETO-CCT
160

Indoor / Wall Lamp



MEGAMAN®
EMMA
170

Indoor / Water Proof Batten



MEGAMAN®
TARON
180



MEGAMAN®
HAGON 2
186

NEW



MEGAMAN®
DINO 2
192



MEGAMAN®
DINO 2 FARM
196

Indoor / Emergency Lighting

** With Self-Test Function



MEGAMAN®
TEMPUS
210



MEGAMAN®
TEMPUS
211



MEGAMAN®
TEMPUS
212



MEGAMAN®
TEMPUS
213



MEGAMAN®
TEMPUS
214



MEGAMAN®
TEMPUS
215



MEGAMAN®
TEMPUS
217



MEGAMAN®
TEMPUS
218



+ VALUE FOR MONEY + RELIABLE + EVERYDAY + LED FIXTURES +



MEGAMAN®
PALMLITE
164



MEGAMAN®
KARINA
166

Indoor / Mirror Light



MEGAMAN®
JUPTIPER
174

NEW



MEGAMAN®
MARS
176

NEW



MEGAMAN®
VENUS
178

NEW

Indoor / Water Proof Batten



MEGAMAN®
ROCCO
200



MEGAMAN®
ROCCA
204

Indoor / Emergency Lighting

* With manual Test Function



MEGAMAN®
TEMPUS
210



MEGAMAN®
TEMPUS
211



MEGAMAN®
TEMPUS
212



MEGAMAN®
TEMPUS
213



MEGAMAN®
TEMPUS
214



MEGAMAN®
TEMPUS
215



MEGAMAN®
TEMPUS
217



MEGAMAN®
TEMPUS
218



Outdoor / Floodlight



MEGAMAN®
HUGO
220



MEGAMAN®
TITO
230

NEW



MEGAMAN®
EKON
234

Outdoor / Bulkhead



MEGAMAN®
**FONDA
Xchange**
244

NEW



+ VALUE FOR MONEY + RELIABLE + EVERYDAY + LED FIXTURES +



MEGAMAN®
VOSS
238



MEGAMAN®
ODI
248



MEGAMAN®
CODY
252



MEGAMAN®
RONDA
256

Garden Lighting



MEGAMAN®
TEKA
260



MEGAMAN®
CAPPI
262

TECHNICAL INFORMATION/



Nomenclature	264
Product Code Glossary	266
Symbol Information	268
Explanation of IP Numbers for Degrees of Protection	269
Chemical Resistance	270

MEGAMAN® RENZO Standby Dim



NEW

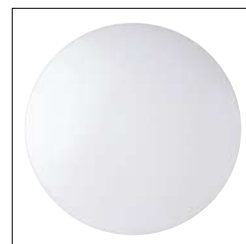

100%

10% or 30%
STAND-BY

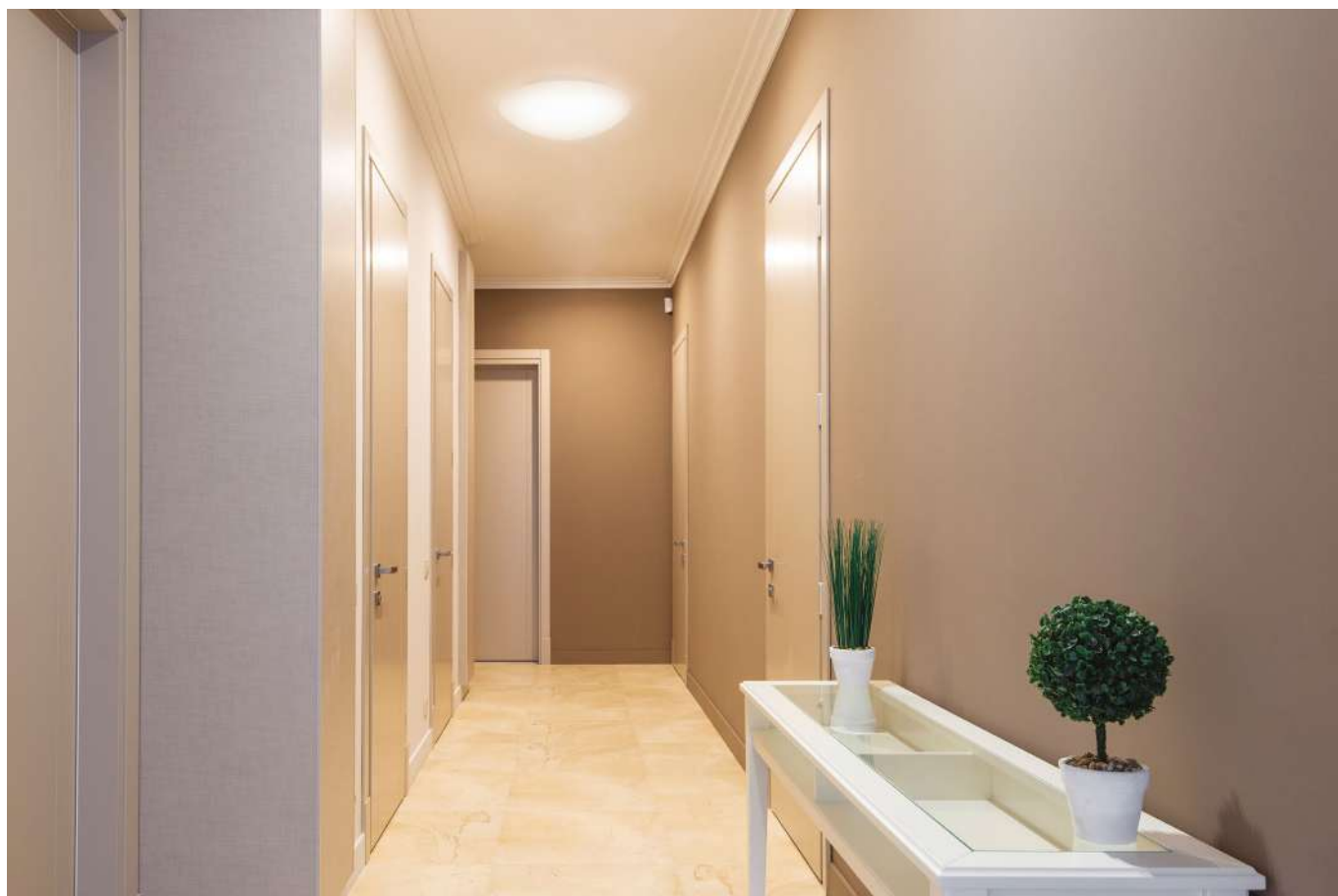

MEGAMAN® RENZO Standby Dim



MEGAMAN® RENZO Standby Dim

Modular LED Bulkhead

MEGAMAN® RENZO standby dim with integrated microwave motion sensor with standby dimming function. Three different sizes, enables to provide ideal solution for different environment and functions. Plug-and-play modular system design of the emergency kit for M and L size enables wholesalers, installers or even end users' in-situ installation according to their needs as well as a flexibility of stock management. MEGAMAN® RENZO standby dim offers Switching CCT options simply flip the integral built-in switch. Selectable lumen output for M and L size in the same embedded switch to enhance visual comfort. Nordic version also available.



Applications

- Hotels
- Bathrooms
- Kitchens
- Corridors
- Residential applications

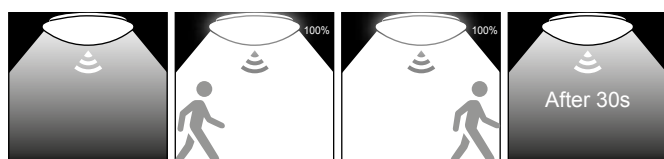
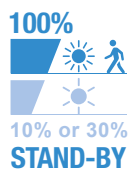

MEGAMAN® RENZO Standby Dim

MEGAMAN® RENZO Standby Dim

Modular LED Bulkhead

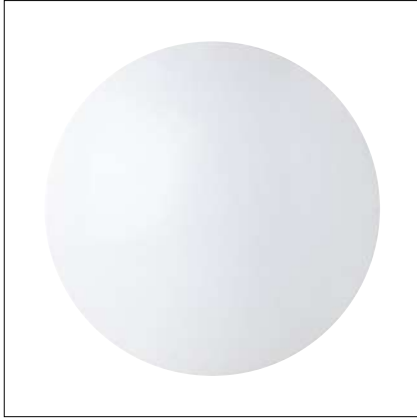

Features

- Integrated microwave motion sensor with standby-dim function.
- Adjustable standby hold time, standby output level (10% or 30%)
- Adjustable detection range, sensor hold time, and daylight priority.
- Plug-and-play emergency modules enhance the installation flexibility
- Dual-CCT (3000K/4000K) by integral built-in switch
- Selectable lumen output
- Homogenous light output with durable PMMA cover avoiding yellowish deterioration
- IP44 & IK03 rated
- High Power factor > 0.9
- Emergency kit with 300lm* output energy backup lasting for 3 hours
- Flicker Free ≤ 3
- Extra-long lifetime up to 50,000 hours L80 B10 at Ta25°C

Ceiling Mounted

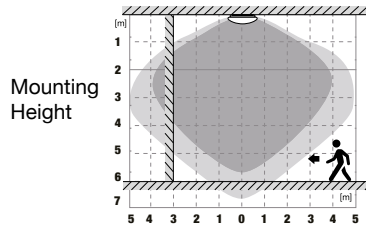

Wall Mounted

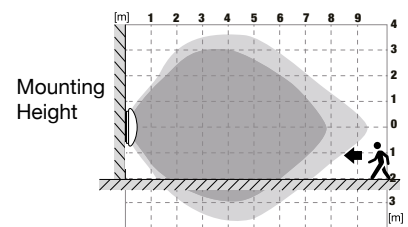

For ceiling mounted luminaire, microwave sensor can sense movement within around 5m radius horizontally, or 6-7m vertically beneath luminaire, and only lights up when movement sensed for energy saving.

For wall mounted luminaire, microwave sensor can sense movement within around 3-4m radius vertically, or 9m front-facing horizontally, and only lights up when movement sensed for energy saving.

Motion Sensor Setting

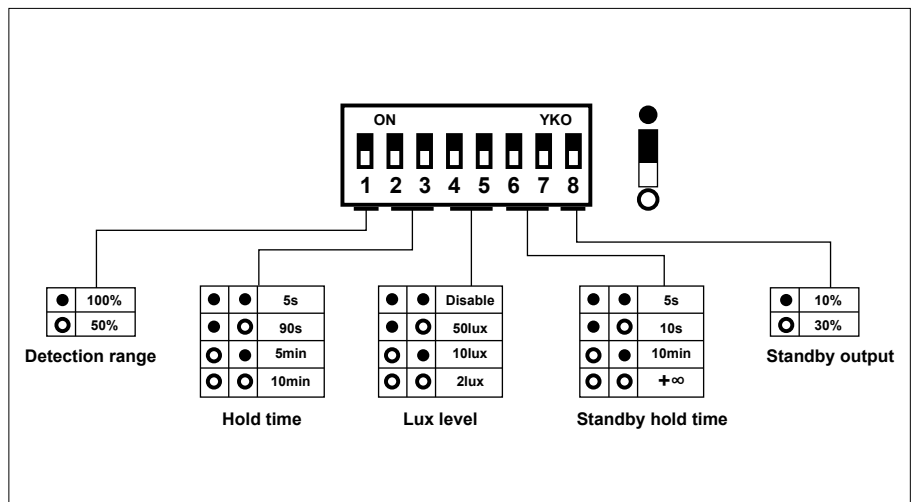

MEGAMAN® RENZO Standby Dim

FCL71600v0-ms/sc



IP44 Class I Flicker Free $\le 3\%$

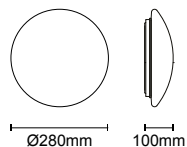

FCL71700v0-ds/ms/sc
FCL71700v0-ds/ms/sc +LA11149



IP44 Class I Flicker Free $\le 3\%$

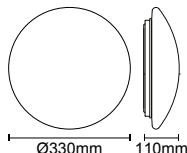

FCL71800v0-ds/ms/sc
FCL71800v0-ds/ms/sc +LA11149



IP44 Class I Flicker Free $\le 3\%$

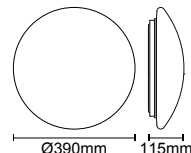

220-240V Rated Life 50,000 hrs L80 B10 @ Ta25°C

White (WH126)

Model No.	Wattage (W)	Luminous Flux (lm)	Luminous Efficacy (lm/W)	Beam Angle (°)	Power Factor (λ)	Dimension (mm)	Material
FCL71600v0-ms/sc	11	930 [3000K] 1000 [4000K]	85 [3000K] 91 [4000K]	110	>0.9	Ø280 x H100	PMMA Diffuser with aluminum housing
FCL71700v0-ds/ms/sc	15/10	1300/930 [3000K] 1400/1000 [4000K]	87/85 [3000K] 93/91 [4000K]	110	>0.9	Ø330 x H110	PMMA Diffuser with aluminum housing
FCL71700v0-ds/ms/sc +LA11149	20/15	1300/930 [3000K] 1400/1000 [4000K]	65/62 [3000K] 73/67 [4000K]	110	>0.9	Ø330 x H110	PMMA Diffuser with aluminum housing
FCL71800v0-ds/ms/sc	22/15/10	1700/1200/1000 [3000K] 1800/1300/1100 [4000K]	90/86/83 [3000K] 94/92/82 [4000K]	110	>0.9	Ø390 x H115	PMMA Diffuser with aluminum housing
FCL71800v0-ds/ms/sc +LA11149	27/20/15	1850/1300/930 [3000K]	68/65/62 [3000K]	110	>0.7	Ø390 x H115	PMMA Diffuser with aluminum housing

FCL71700v0-ds/ms/sc
FCL72600v0-ds/ms/sc

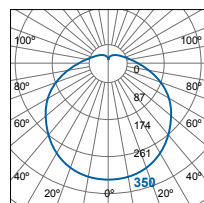

m	Lux	Ø cm
0.5	1400	173
1	350	346
1.5	156	520
2	88	693

Beam angle = 120°

FCL71800v0-ds/ms/sc

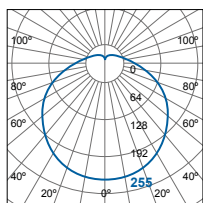

m	Lux	Ø cm
0.5	1920	173
1	480	346
1.5	213	520
2	120	693

Beam angle = 120°

MEGAMAN® RENZO Standby Dim

FCL72600v0-ds/ms/sc
 FCL72600v0-ds/ms/sc +LA11149



IP44 Class I Flicker Free

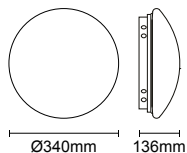

220-240V Rated Life 50,000 hrs L80 B10 @ Ta25°C

White (WH26)

Nordic Version

Model No.		Wattage (W)	Luminous Flux (lm)	Luminous Efficacy (lm/W)	Beam Angle (°)	Power Factor (λ)	Dimension (mm)	Material
FCL72600v0-ds/ms/sc		15/11	1300/930 [3000K] 1400/1000 [4000K]	87/85 [3000K] 88/91 [4000K]	110	>0.9	Ø340 x H136	PMMA Diffuser with aluminum housing
FCL72600v0-ds/ms/sc +LA11149		20/15	1300/930 [3000K] 1400/1000 [4000K]	87/85 [3000K] 88/91 [4000K]	110	>0.7	Ø340 x H136	PMMA Diffuser with aluminum housing



LA11149
 Emergency Kit
 Module

MEGAMAN® RENZO Standby Dim



MEGAMAN® RENZO



MEGAMAN® RENZO



MEGAMAN® RENZO

Modular LED Bulkhead

MEGAMAN® RENZO consists of 3 unique MEGAMAN® luminaire design elements, Modular System, Switching CCT and Selectable lumen output; together with 4 different sizes: S, M, L and XL, enables to provide ideal solution for different environment and functions. Plug-and-play modular system design enables wholesalers, installers or even end users' in-situ installation according to their needs, such as Microwave motion sensor and emergency kit. This not only enhances the flexibility; but also creates the ease of stock management. MEGAMAN® RENZO offers Switching CCT options (3000K/4000K) apart from the standard 4000K CCT version. Just by a simple flip in the MEGAMAN® RENZO integral built-in switch, user can change the colour temperature, in order to create a different lighting atmosphere. Selectable lumen output (1000/1400/2000lm) for MEGAMAN® RENZO L size in the same embedded switch, to ensure MEGAMAN® RENZO always provide maximum visual comfort, even with the natural light source.

This collection is also tailored to meet market's requirements in aestheticity with its unobtrusive, simple yet elegant design, and fulfill requirement of durability with Polymethyl Methacrylate (PMMA) cover and IP44 waterproof protective construction material.

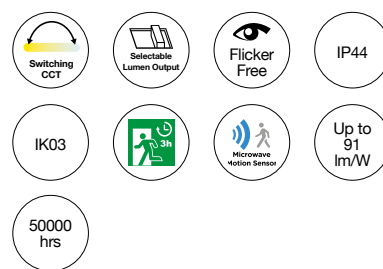

Applications

- Hotels
- Bathrooms
- Kitchens
- Corridors
- Residential applications

Plug-and-Play Modular Design

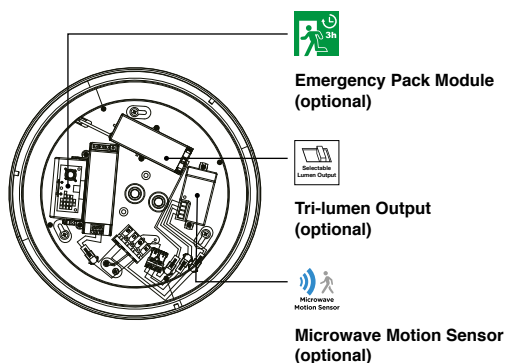

MEGAMAN® RENZO

MEGAMAN® RENZO

Modular LED Bulkhead

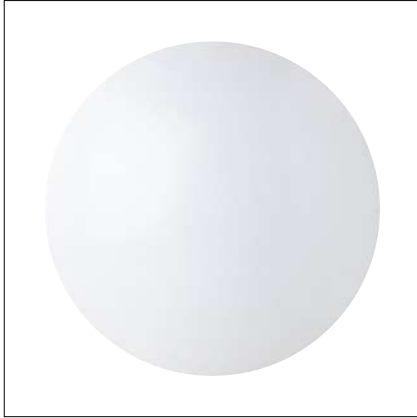

Features

- Plug-and-play modular design enhances the installation flexibility
- Compatible to microwave motion sensor and emergency modules in MEGAMAN® RENZO S, M, L and XL sizes
- Dual-CCT (3000K/4000K) by integral built-in switch apart from 4000K standard version
- Dual-lumen (1000/1400lm) and Tri-lumen (1000/1400/2000lm). Output selection for MEGAMAN® RENZO M and L size respectively
- Tri-lumen (1400/2000/3000lm). Output selection for MEGAMAN® RENZO XL size
- All above features offer full aspect of flexibility of stock management
- Homogeneous light output with durable PMMA cover avoiding yellowish deterioration
- IP44 & IK03 rated
- High Power factor >0.9
- Emergency kit with 300lm output energy backup lasting for 3 hours
- MEGAMAN® RENZO with microwave motion sensor can serve as a master device to control other without sensor device as slaves in a group with loop through wiring connection
- Flicker free
- Extra long lifetime up to 50,000 hours L80 B10 at Ta25°C

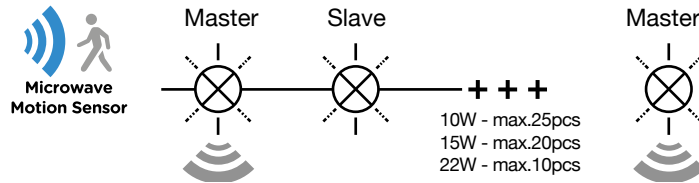

- Maximum Connection for microwave motion sensor master-slave looping for 10W is 25pcs; for 15W is 20pcs; for 22W is 10pcs

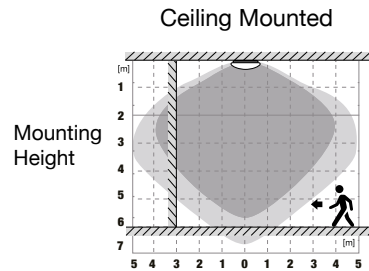

For ceiling mounted **RENZO**, microwave sensor can sense movement within around 5m radius horizontally, or 6-7m vertically beneath **RENZO**, and only lights up when movement sensed for energy saving.

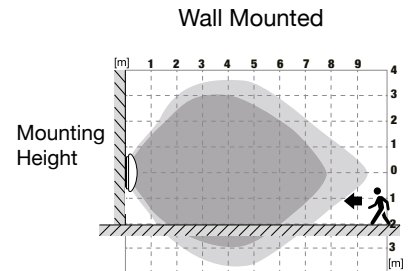

For wall mounted **RENZO**, microwave sensor can sense movement within around 3-4m radius vertically, or 9m front-facing horizontally, and only lights up when movement sensed for energy saving.

Indoor Lighting / Bulkhead

MEGAMAN® RENZO

FCL71600v0-sc
FCL71600v0-sc+LA11149
FCL71600v0-sc+LA10175



IP44 Class I Flicker Free

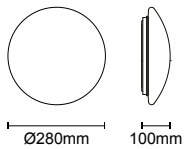

FCL71700v0-ds/sc
FCL71700v0-ds/sc+LA10175
FCL71700v0-ds/sc+LA11149
FCL71700v0-ds/sc+LA10175+LA11149



IP44 Class I Flicker Free

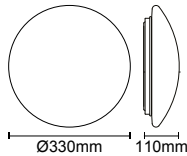

FCL71800v0-ds-sc
FCL71800v0-ds-sc+LA11149
FCL71800v0-ds-sc+LA10175
FCL71800v0-ds-sc+LA10175+LA11149



IP44 Class I Flicker Free

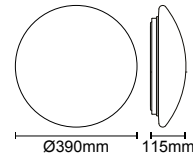

220-240V

Rated Life 50,000 hrs L80 B10 @ Ta25°C

White (WH26)

DUAL CCT

Model No.	Features	Wattage (W)	Luminous Flux (lm)	Luminous Efficacy (lm/W)	Beam Angle (°)	Power Factor (λ)	Dimension (mm)	Remarks
FCL71600v0-sc	1, 5	10	930 [3000K] 1000 [4000K]	93 [3000K] 100 [4000K]	120	>0.9	Ø280 x H100	10
FCL71600v0-sc+LA10175	3, 6	11	930 [3000K] 1000 [4000K]	85 [3000K] 91 [4000K]	120	>0.7	Ø280 x H100	10
FCL71600v0-sc+LA11149	2, 7	14	930 [3000K] 1000 [4000K]	66 [3000K] 71 [4000K]	120	>0.7	Ø280 x H100	10
FCL71700v0-ds/sc	1, 5, 12	14/10	1300/930 [3000K] 1400/1000 [4000K]	93/93 [3000K] 100/100 [4000K]	120	>0.9	Ø330 x H110	10
FCL71700v0-ds/sc+LA10175	3, 6, 12	15/11	1300/930 [3000K] 1400/1000 [4000K]	87/85 [3000K] 93/91 [4000K]	120	>0.7	Ø330 x H110	10
FCL71700v0-ds/sc+LA11149	2, 7, 12	18/14	1300/930 [3000K] 1400/1000 [4000K]	72/66 [3000K] 78/71 [4000K]	120	>0.7	Ø330 x H110	10
FCL71700v0-ds/sc+LA10175+LA11149	4, 8, 12	19/15	1300/930 [3000K] 1400/1000 [4000K]	68/62 [3000K] 74/67 [4000K]	120	>0.7	Ø330 x H110	11
FCL71800v0-ds-sc	1, 5, 9	20/15/10	1850/1300/930 [3000K] 2000/1400/1000 [4000K]	93/87/93 [3000K] 100/93/100 [4000K]	120	>0.9	Ø390 x H115	11
FCL71800v0-ds-sc+LA10175	3, 6, 9	21/16/11	1850/1300/930 [3000K] 2000/1400/1000 [4000K]	88/81/85 [3000K] 95/88/91 [4000K]	120	>0.7	Ø390 x H115	11
FCL71800v0-ds-sc+LA11149	2, 7, 9	24/19/14	1850/1300/930 [3000K] 2000/1400/1000 [4000K]	77/68/66 [3000K] 83/74/71 [4000K]	120	>0.7	Ø390 x H115	11
FCL71800v0-ds-sc+LA10175+LA11149	4, 8, 9	25/20/15	1850/1300/930 [3000K] 2000/1400/1000 [4000K]	74/65/62 [3000K] 80/70/67 [4000K]	120	>0.7	Ø390 x H115	11

- 1 Standard (DUAL CCT)
- 2 Standard (DUAL CCT) + Emergency Kit Module
- 3 Standard (DUAL CCT) + Microwave Motion Sensor
- 4 Standard (DUAL CCT) + Emergency Kit Module + Microwave Motion Sensor
- 5 Working temperature of basic RENZO module: -30°C to +40°C
- 6 Working temperature of microwave motion sensor at -20°C to +40°C
- 7 Working temperature of emergency kit module at 0°C to +45°C
- 8 Working temperature of models with emergency kit module + microwave motion sensor at 0°C to +40°C
- 9 Tri-lumen output
- 10 Due to limited space, only compatible to either microwave motion sensor OR emergency kit module at a time
- 11 Compatible to microwave motion sensor AND emergency kit module at the same time
- 12 DUAL-lumen output

MEGAMAN® RENZO

FCL76000v0-ds/sc
 FCL76000v0-ds/sc+LA10175
 FCL76000v0-ds/sc+LA11149
 FCL76000v0-ds/sc+LA10175+LA11149

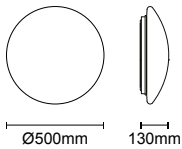
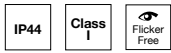

220-240V Rated Life 50,000 hrs L80 B10 @ Ta25°C

White (WH26)

DUAL CCT									
Model No.	Features	Wattage (W)	Luminous Flux (lm)	Luminous Efficacy (lm/W)	Beam Angle (°)	Power Factor (λ)	Dimension (mm)	Remarks	
FCL76000v0-ds/sc	1, 5, 9	30/20/14	2850/1900/1330@3000K 3000/2000/1400@4000K	95 [3000K] 100 [4000K]	120	>0.9	Ø500 x H130	11	
FCL76000v0-ds/sc+LA10175	3, 6, 9	31/21/15	2850/1900/1330@3000K 3000/2000/1400@4000K	92/90/89 [3000K] 97/95/93 [4000K]	120	>0.7	Ø500 x H130	11	
FCL76000v0-ds/sc+LA11149	2, 7, 9	34/24/18	2850/1900/1330@3000K 3000/2000/1400@4000K	84/79/74 [3000K] 88/83/78 [4000K]	120	>0.7	Ø500 x H130	11	
FCL76000v0-ds/sc+LA10175+LA11149	4, 8, 9	35/25/19	2850/1900/1330@3000K 3000/2000/1400@4000K	81/76/70 [3000K] 96/80/74 [4000K]	120	>0.9	Ø500 x H130	11	



LA10175
Microwave Motion Sensor



LA11149
Emergency Kit Module

- 1 Standard (SINGLE CCT)
- 2 Standard (SINGLE CCT) + Emergency Kit Module
- 3 Standard (SINGLE CCT) + Microwave Motion Sensor
- 4 Standard (SINGLE CCT) + Emergency Kit Module + Microwave Motion Sensor
- 5 Working temperature of basic RENZO module: -30°C to +40°C
- 6 Working temperature of microwave motion sensor at -20°C to +40°C
- 7 Working temperature of emergency kit module at 0°C to +45°C
- 8 Working temperature of models with emergency kit module + microwave motion sensor at 0°C to +40°C
- 9 Tri-lumen output
- 10 Due to limited space, only compatible to either microwave motion sensor OR emergency kit module at a time
- 11 Compatible to microwave motion sensor and emergency kit module at the same time
- 12 DUAL-lumen output

Indoor Lighting / Bulkhead

MEGAMAN® RENZO

FCL71600v0
FCL71600v0+LA10175
FCL71600v0+LA11149



IP44 Class I Flicker Free

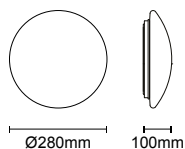

FCL71700v0-ds
FCL71700v0-ds+LA10175
FCL71700v0-ds+LA11149
FCL71700v0-ds+LA10175+LA11149



IP44 Class I Flicker Free

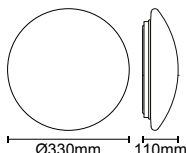

FCL71800v0-ds
FCL71800v0-ds+LA10175
FCL71800v0-ds+LA11149
FCL71800v0-ds+LA10175+LA11149



IP44 Class I Flicker Free

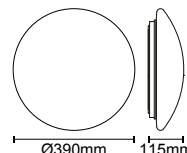

220-240V Rated Life 50,000 hrs L80 B10 @ Ta25°C

White (WH26)

4000K only

Model No.	Features	Wattage (W)	Luminous Flux (lm)	Luminous Efficacy (lm/W)	Beam Angle (°)	Power Factor (λ)	Dimension (mm)	Remarks
FCL71600v0		10	1000	100	120	>0.9	Ø280 x H100	10
FCL71600v0+LA10175		11	1000	91	120	>0.7	Ø280 x H100	10
FCL71600v0+LA11149		14	1000	71	120	>0.7	Ø280 x H100	10
FCL71700v0-ds		14/10	1400/1000	100/100	120	>0.9	Ø330 x H110	11
FCL71700v0-ds+LA10175		15/11	1400/1000	93/91	120	>0.7	Ø330 x H110	11
FCL71700v0-ds+LA11149		18/14	1400/1000	78/71	120	>0.7	Ø330 x H110	11
FCL71700v0-ds+LA10175+LA11149	 	19/15	1400/1000	74/67	120	>0.7	Ø330 x H110	11
FCL71800v0-ds		20/15/10	2000/1400/1000	100/93/100	120	>0.9	Ø390 x H115	11
FCL71800v0-ds+LA10175		21/16/11	2000/1400/1000	95/88/91	120	>0.7	Ø390 x H115	11
FCL71800v0-ds+LA11149		24/19/14	2000/1400/1000	83/74/71	120	>0.7	Ø390 x H115	11
FCL71800v0-ds+LA10175+LA11149	 	25/20/15	2000/1400/1000	80/70/67	120	>0.7	Ø390 x H115	11



LA10175
Microwave Motion
Sensor



LA11149
Emergency Kit
Module

- 1 Standard (SINGLE CCT)
- 2 Standard (SINGLE CCT) + Emergency Kit Module
- 3 Standard (SINGLE CCT) + Microwave Motion Sensor
- 4 Standard (SINGLE CCT) + Emergency Kit Module + Microwave Motion Sensor
- 5 Working temperature of basic RENZO module: -30°C to +40°C
- 6 Working temperature of microwave motion sensor at -20°C to +40°C
- 7 Working temperature of emergency kit module at 0°C to +45°C
- 8 Working temperature of models with emergency kit module + microwave motion sensor at 0°C to +40°C
- 9 Tri-lumen output
- 10 Due to limited space, only compatible to either microwave motion sensor OR emergency kit module at a time
- 11 Compatible to microwave motion sensor and emergency kit module at the same time
- 12 DUAL-lumen output

MEGAMAN® RENZO

FCL72600v0-ds/sc
 FCL72600v0-ds/sc+LA10175
 FCL72600v0-ds/sc+LA11149
 FCL72600v0-ds/sc+LA10175+LA11149



IP44 Class I Flicker Free

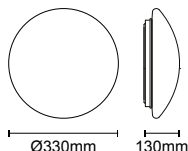

220-240V Rated Life 50,000 hrs L80 B10 @ Ta25°C

White (WH26)

Nordic Version | DUAL CCT

Model No.	Features	Wattage (W)	Luminous Flux (lm)	Luminous Efficacy (lm/W)	Beam Angle (°)	Power Factor (λ)	Dimension (mm)	Remarks
FCL72600v0-ds/sc	1, 5, 12	14/10	1300/930 [3000K] 1400/1000 [4000K]	93/93 [3000K] 100/100 [4000K]	120	>0.9	Ø330 x H130	11
FCL72600v0-ds/sc+LA10175	3, 6, 12	15/11	1300/930 [3000K] 1400/1000 [4000K]	87/85 [3000K] 93/91 [4000K]	120	>0.7	Ø330 x H130	11
FCL72600v0-ds/sc+LA11149	2, 7, 12	18/14	1300/930 [3000K] 1400/1000 [4000K]	72/66 [3000K] 78/71 [4000K]	120	>0.7	Ø330 x H130	11
FCL72600v0-ds/sc+LA10175+LA11149	4, 8, 12	19/15	1300/930 [3000K] 1400/1000 [4000K]	68/62 [3000K] 74/67 [4000K]	120	>0.7	Ø330 x H130	11

Nordic Version



The diameter fits the diagonal of junction box



Knockout for conduit connection



LA10175
Microwave Motion Sensor

LA11149
Emergency Kit Module

- 1 Standard (DUAL CCT)
- 2 Standard (DUAL CCT) + Emergency Kit Module
- 3 Standard (DUAL CCT) + Microwave Motion Sensor
- 4 Standard (DUAL CCT) + Emergency Kit Module + Microwave Motion Sensor
- 5 Working temperature of basic RENZO module: -30°C to +40°C
- 6 Working temperature of microwave motion sensor at -20°C to +40°C
- 7 Working temperature of emergency kit module at 0°C to +45°C
- 8 Working temperature of models with emergency kit module + microwave motion sensor at 0°C to +40°C
- 9 Tri-lumen output
- 10 Due to limited space, only compatible to either microwave motion sensor OR emergency kit module at a time
- 11 Compatible to microwave motion sensor and emergency kit module at the same time
- 12 DUAL-lumen output

MEGAMAN® RENZO

FCL73500v0-sc

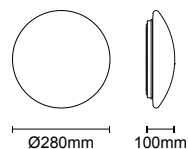
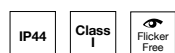

FCL73600v0-ds/sc
FCL73600v0-ds/sc+LA10175

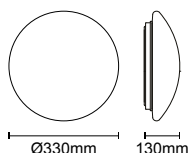
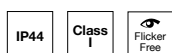

220-240V

Rated Life 50,000 hrs L80 B10 @ Ta25°C

DUAL CCT

Model No.	Features	Wattage (W)	Luminous Flux (lm)	Luminous Efficacy (lm/W)	Beam Angle (°)	Power Factor (λ)	Dimension (mm)	Remarks
FCL73500v0-sc	1, 5	10	930 [3000K] 1000 [4000K]	93 [3000K] 100 [4000K]	120	>0.9	Ø280 x H110	10
FCL73600v0-ds/sc	1, 5, 12	14/10	1300/930 [3000K] 1400/1100 [4000K]	93/93 [3000K] 100/100 [4000K]	120	>0.7	Ø330 x H110	10
FCL73600v0-ds/sc+LA10175 	3, 6, 12	15/11	1300/930 [3000K] 1400/1100 [4000K]	87/85 [3000K] 93/91 [4000K]	120	>0.7	Ø330 x H110	10



LA10175
Microwave Motion
Sensor

- 1 Standard (DUAL CCT)
- 2 Standard (DUAL CCT) + Emergency Kit Module
- 3 Standard (DUAL CCT) + Microwave Motion Sensor
- 4 Standard (DUAL CCT) + Emergency Kit Module + Microwave Motion Sensor
- 5 Working temperature of basic RENZO module: -30°C to +40°C
- 6 Working temperature of microwave motion sensor at -20°C to +40°C
- 7 Working temperature of emergency kit module at 0°C to +45°C
- 8 Working temperature of models with emergency kit module + microwave motion sensor at 0°C to +40°C
- 9 Tri-lumen output
- 10 Due to limited space, only compatible to either microwave motion sensor OR emergency kit module at a time
- 11 Compatible to microwave motion sensor and emergency kit module at the same time
- 12 DUAL-lumen output

MEGAMAN® RENZO

FCL72600v0-ds
 FCL72600v0-ds+LA10175
 FCL72600v0-ds+LA11149
 FCL72600v0-ds+LA10175+LA11149

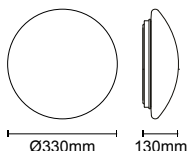
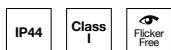

220-240V
 Rated Life 50,000 hrs L80 B10 @ Ta25°C

White (WH26)

Nordic Version | 4000K only

Model No.	Features	Wattage (W)	Luminous Flux (lm)	Luminous Efficacy (lm/W)	Beam Angle (°)	Power Factor (λ)	Dimension (mm)	Remarks
FCL72600v0-ds	1, 5, 12	14/10	1400/1000	100/100	120	>0.9	Ø330 x H130	10
FCL72600v0-ds+LA10175	3, 6, 12	15/11	1400/1000	93/91	120	>0.7	Ø330 x H130	10
FCL72600v0-ds+LA11149	2, 7, 12	18/14	1400/1000	78/71	120	>0.7	Ø330 x H130	10
FCL72600v0-ds+LA10175+LA11149	4, 8, 12	19/15	1400/1000	74/67	120	>0.7	Ø330 x H130	10

Nordic Version



The diameter fits the diagonal of junction box



Knockout for conduit connection



LA10175
 Microwave Motion Sensor



LA11149
 Emergency Kit Module

- 1 Standard (DUAL CCT)
- 2 Standard (DUAL CCT) + Emergency Kit Module
- 3 Standard (DUAL CCT) + Microwave Motion Sensor
- 4 Standard (DUAL CCT) + Emergency Kit Module + Microwave Motion Sensor
- 5 Working temperature of basic RENZO module: -30°C to +40°C
- 6 Working temperature of microwave motion sensor at -20°C to +40°C
- 7 Working temperature of emergency kit module at 0°C to +45°C
- 8 Working temperature of models with emergency kit module + microwave motion sensor at 0°C to +40°C
- 9 Tri-lumen output
- 10 Due to limited space, only compatible to either microwave motion sensor OR emergency kit module at a time
- 11 Compatible to microwave motion sensor and emergency kit module at the same time
- 12 DUAL-lumen output

RENZO Photometric Data

FCL71600v0-sc
FCL71600v0-sc+LA10175
FCL71600v0-sc+LA11149

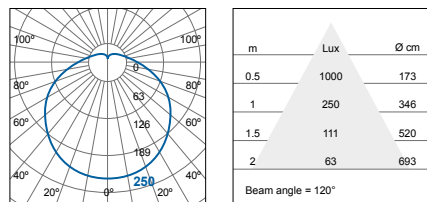

FCL71700v0-ds/sc
FCL71700v0-ds/sc+LA10175
FCL71700v0-ds/sc+LA11149
FCL71700v0-ds/sc+LA10175+LA11149

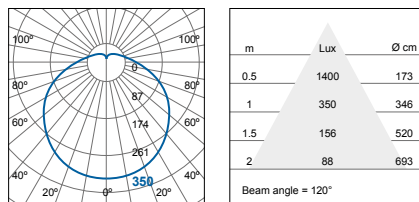

FCL71800v0-ds/sc
FCL71800v0-ds/sc+LA10175
FCL71800v0-ds/sc+LA11149
FCL71800v0-ds/sc+LA10175+LA11149

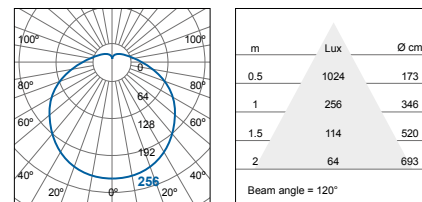

FCL71600v0
FCL71600v0+LA10175
FCL71600v0+LA11149

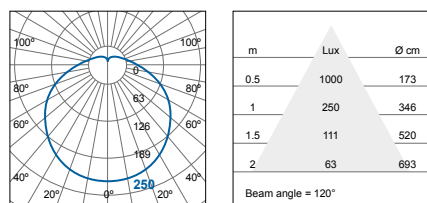

FCL71700v0-ds
FCL71700v0-ds+LA10175
FCL71700v0-ds+LA11149
FCL71700v0-ds+LA10175+LA11149

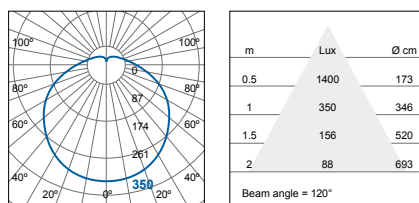

FCL71800v0-ds
FCL71800v0-ds+LA10175
FCL71800v0-ds+LA11149
FCL71800v0-ds+LA10175+LA11149

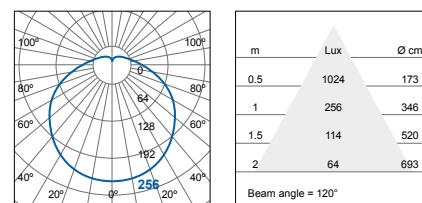

FCL72600v0-ds/sc
FCL72600v0-ds/sc+LA10175
FCL72600v0-ds/sc+LA11149
FCL72600v0-ds/sc+LA10175+LA11149

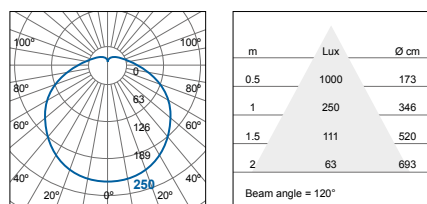

FCL72600v0-ds
FCL72600v0-ds+LA10175
FCL72600v0-ds+LA11149
FCL72600v0-ds+LA10175+LA11149

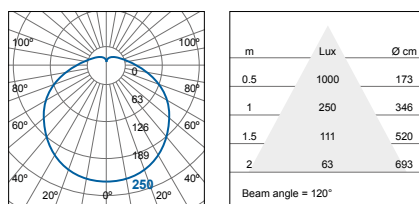

FCL73500v0-sc

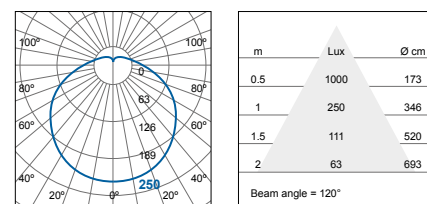

FCL73600v0-ds/sc
FCL73600v0-ds/sc+LA10175

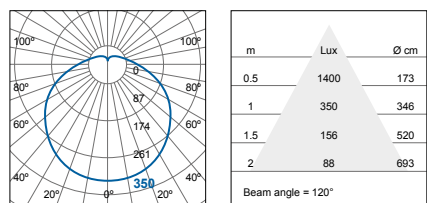

MEGAMAN® JOSIE



MEGAMAN® JOSIE



MEGAMAN® JOSIE

Integrated LED Bulkhead

MEGAMAN® JOSIE is an integrated LED bulkhead with Ultra Slim design which offers uniform light distribution and decorative backlight. MEGAMAN® JOSIE with switch dimming function allows 3 steps dimming with memory function provides flexibility of end users. It is perfect for everyday lighting.

Features

- Step-dimming 100% 50% 20% control over ON/OFF switch with memory function
- Ultra Slim design, profile less than 23mm
- Excellent and uniform lighting performance thanks to side-lit light guide technology
- Easy installation featured with twist-and-lock
- Tool-less wiring connection design
- IP54 version available for moisture application



Applications

- Hotels
- Kitchens
- Corridors
- Residential

Accessories

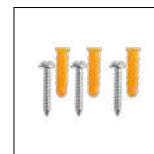

MEGAMAN® JOSIE

FCL72900v0-ds

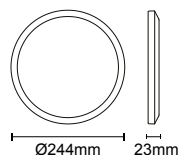

FCL73000v0-ds

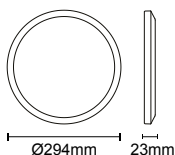

FCL73100v0-ds

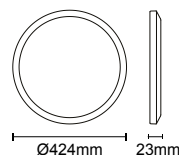

220-240V

White (WH12)

Model No.	Wattage (W)	Luminous Flux (lm)	Beam Angle (°)	Dimension (mm)	Dimming	Colour Temp. [CRI]	Rated Life at L70B50 at Ta25°C (hrs)	Materials
FCL72900v0-ds	11	1250	120	Ø244 x 23	3-step dimming 100%-50%-20%	2700K / 6500K	25000	Plastic housing + PS diffuser
FCL73000v0-ds	14.5	1600	120	Ø294 x 23	3-step dimming 100%-50%-20%	2700K / 6500K	25000	Plastic housing + PS diffuser
FCL73100v0-ds	19	2100	120	Ø424 x 23	3-step dimming 100%-50%-20%	2700K / 6500K	25000	Plastic housing + PS diffuser

FCL72900v0-ds (2700K)

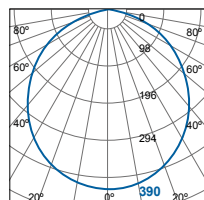

m	Lux	Ø cm
0.5	1560	173
1	390	346
1.5	173	520
2	98	693

Beam angle = 120°

FCL73000v0-ds (2700K)

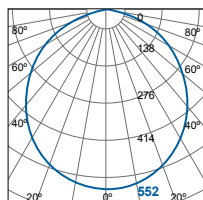

m	Lux	Ø cm
0.5	2208	173
1	552	346
1.5	245	520
2	138	693

Beam angle = 120°

FCL73100v0-ds (2700K)

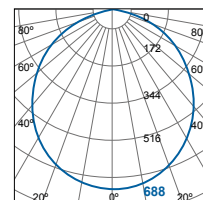

m	Lux	Ø cm
0.5	2752	173
1	688	346
1.5	306	520
2	172	693

Beam angle = 120°

FCL72900v0-ds (6500K)

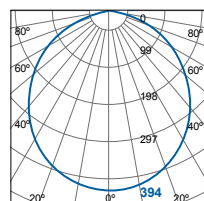

m	Lux	Ø cm
0.5	1576	173
1	394	346
1.5	175	520
2	99	693

Beam angle = 120°

FCL73000v0-ds (6500K)

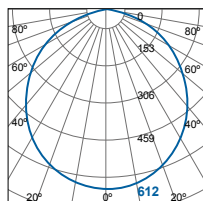

m	Lux	Ø cm
0.5	2448	173
1	612	346
1.5	272	520
2	153	693

Beam angle = 120°

FCL73100v0-ds (6500K)

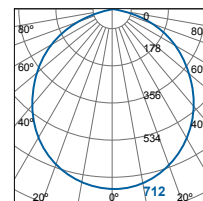

m	Lux	Ø cm
0.5	2848	173
1	712	346
1.5	316	520
2	178	693

Beam angle = 120°

Indoor Lighting / Bulkhead

MEGAMAN® JOSIE

FCL73200v0-ds

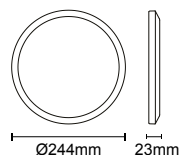

FCL73300v0-ds

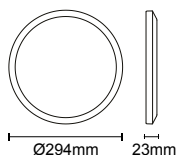

FCL73400v0-ds

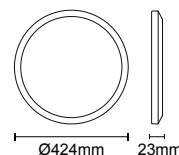

220-240V

White (WH12)

Model No.	Wattage (W)	Luminous Flux (lm)	Beam Angle (°)	Dimension (mm)	Dimming	Colour Temp. [CRI]	Rated Life at L70B50 at Ta25°C (hrs)	Materials
FCL73200v0-ds	15	1250	120	Ø244 x 23	3-step dimming 100%-50%-20%	2700K / 6500K	25000	Plastic housing + PS diffuser
FCL73300v0-ds	18	1600	120	Ø294 x 23	3-step dimming 100%-50%-20%	2700K / 6500K	25000	Plastic housing + PS diffuser
FCL73400v0-ds	22	2100	120	Ø424 x 23	3-step dimming 100%-50%-20%	2700K / 6500K	25000	Plastic housing + PS diffuser

FCL73200v0-ds (2700K)

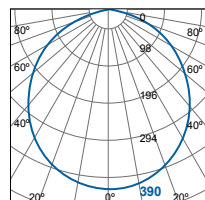

m	Lux	Ø cm
0.5	1560	173
1	390	346
1.5	173	520
2	98	693

Beam angle = 120°

FCL73300v0-ds (2700K)

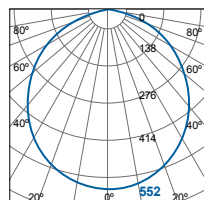

m	Lux	Ø cm
0.5	2208	173
1	552	346
1.5	245	520
2	138	693

Beam angle = 120°

FCL73400v0-ds (2700K)

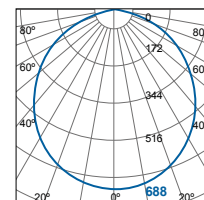

m	Lux	Ø cm
0.5	2752	173
1	688	346
1.5	306	520
2	172	693

Beam angle = 120°

FCL73200v0-ds (6500K)

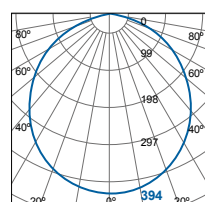

m	Lux	Ø cm
0.5	1576	173
1	394	346
1.5	175	520
2	99	693

Beam angle = 120°

FCL73300v0-ds (6500K)

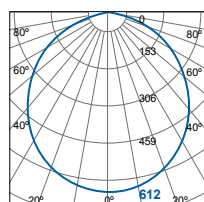

m	Lux	Ø cm
0.5	2448	173
1	612	346
1.5	272	520
2	153	693

Beam angle = 120°

FCL73400v0-ds (6500K)

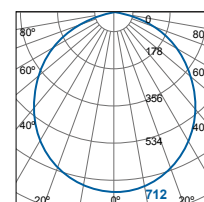

m	Lux	Ø cm
0.5	2848	173
1	712	346
1.5	316	520
2	178	693

Beam angle = 120°

MEGAMAN® AATOS



MEGAMAN® AATOS

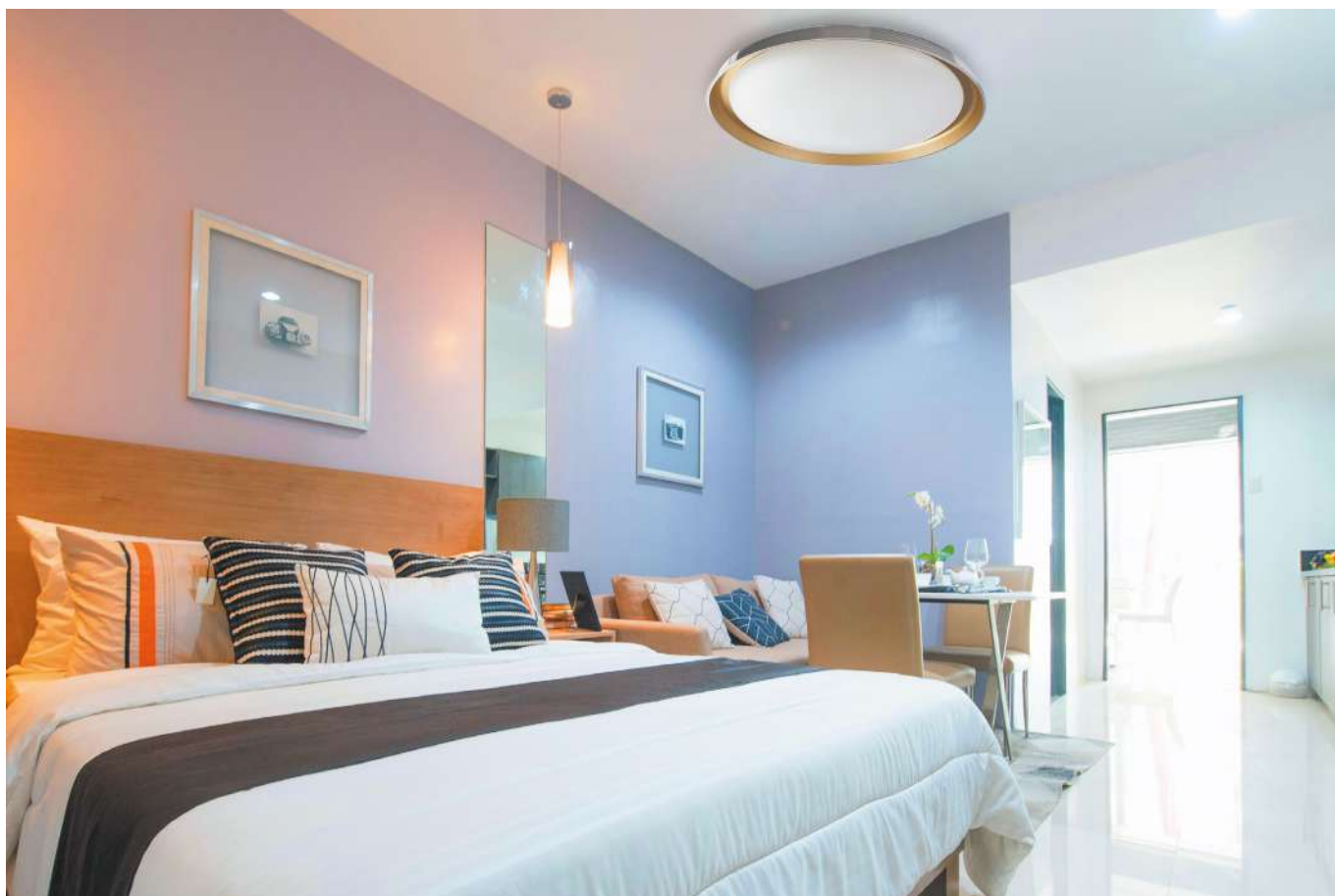

MEGAMAN® AATOS

Integrated LED Bulkhead

MEGAMAN® AATOS is an integrated ceiling mounted LED luminaire with tunable white and dimmable features. It comes with a polychromatic shade that delivers flexibility for lighting design. MEGAMAN® AATOS offers a comprehensive choices of version including two sizes that can be utilized in versatile application including living room, bedroom and rest areas which could be easily operated by a remote controller.

Features

- Tunable white colour changing from 3000K to 6500K and dimmable functions offer flexibility of lighting design
- Easy operation via a remote controller
- Up to 80% energy saving compared to standard incandescent light sources
- Seamless dimming from 100% to 5%
- 2 different finishings (white & chrome)
- With memory function



Applications

- Living room
- Bedroom
- Restaurants
- Hotels
- Lobby

MEGAMAN® AATOS

FCL73900v0-tw

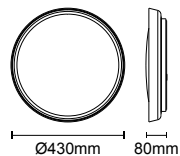

FCL74000v0-tw

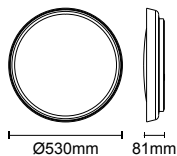

220-240V



Model No.	Wattage (W)	Luminous Flux (lm)	Beam Angle (°)	Dimension (mm)	Colour Temp. [CRI]	Rated Life at L70B50 at Ta25°C (hrs)	Materials
FCL73900v0-tw	30	2100	120	Ø430 x H80	3000K to 6500K Dimmable	25000	PMMA Diffuser + Metal Housing
FCL74000v0-tw	60	4300	120	Ø530 x H81	3000K to 6500K Dimmable	25000	PMMA Diffuser + Metal Housing

Accessories



Remote included

* 2x1.5VDC AAA battery not included

MEGAMAN® AATOS



MEGAMAN® AATOS STARRY



MEGAMAN® AATOS STARRY

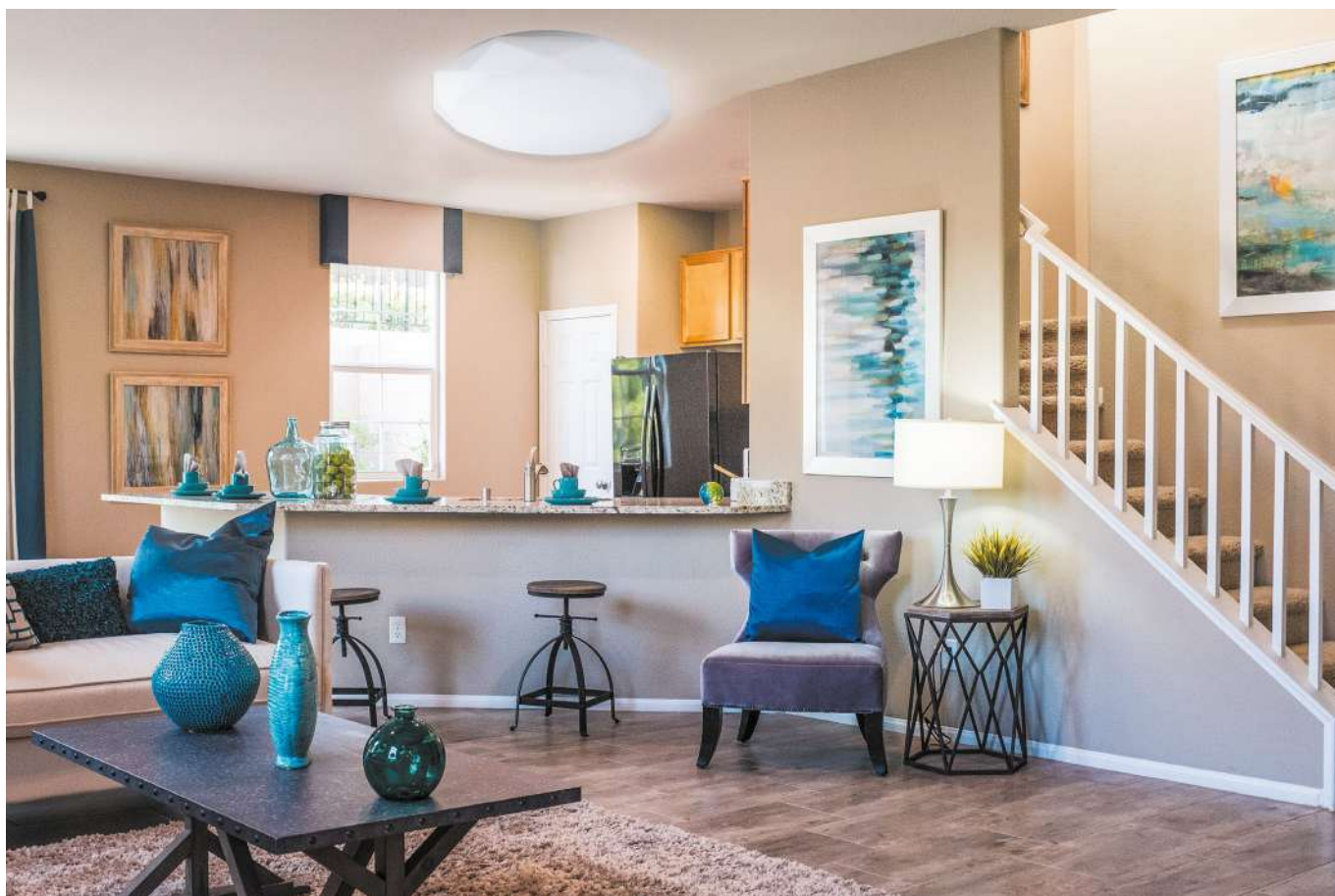

MEGAMAN® AATOS STARRY

Integrated LED Bulkhead

MEGAMAN® AATOS STARRY is an integrated ceiling mounted LED luminaire with tunable white and colour changing features. It impresses with its fascinating starry-sky look as small stars sparkle. MEGAMAN® AATOS STARRY offers various light effect that can be utilized in versatile application including living room, lobby and rest areas which could be easily operated by a remote controller or app via mobile phone.

Features

- Tunable white and colour changing functions offer flexibility of lighting design
- Easy operation via a remote controller or app via mobile phone
- Up to 80% energy saving compared to standard incandescent light sources
- Smooth dimming from 100% to 10%
- Uniform light distribution
- Smooth surface for easy cleaning
- Night mode available
- With memory function



Applications

- Living room
- Lobby
- Restaurants
- Hotels

MEGAMAN® AATOS STARRY

FCL74100v0-wf/ec/tw

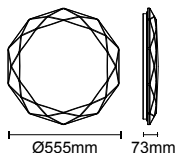

220-240V

White (WH26)

Model No.	Wattage (W)	Luminous Flux (lm)	Beam Angle (°)	Dimension (mm)	Colour Temp. [CRI]	Rated Life at L70B50 at Ta25°C (hrs)	Materials
FCL74100v0-wf/ec/tw	60	4200	120	Ø555 x H73	3000K to 6500K Dimmable RGB Colour Changing	25000	PMMA Diffuser + Metal Housing

Accessories



Remote included

* 2x1.5VDC AAA battery not included

MEGAMAN® AATOS STARRY



MEGAMAN® KATIA

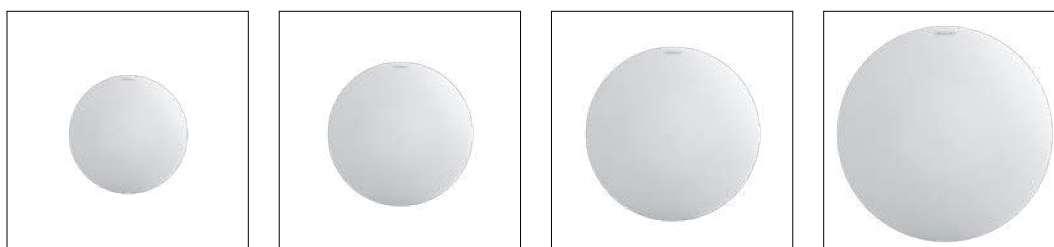



MEGAMAN® KATIA

Integrated LED Bulkhead

MEGAMAN® KATIA is a brilliant and timeless design with ultra slim housing, this stylish ceiling lamp spreads an even light that illuminates the whole room with comfort.

Features

- Round and slim profile
- Delivers wide range of lumen package for direct alternatives to traditional wall and ceiling lamp
- Easy installation and tool-less wiring
- IP40 protection
- Operation temperature -20°C to 40°C
- Mounting kit for junction box available

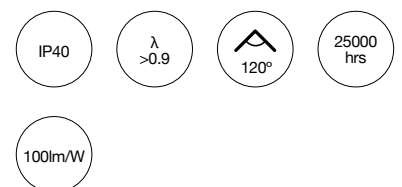

Applications

- Kitchens
- Corridors
- Residential
- Hotels

Easy Installation



Accessories



LA10209
 Mounting kit for
 junction box



Junction box is not
 included

MEGAMAN® KATIA

FCL74200v0

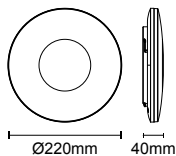

FCL74300v0

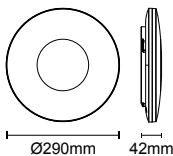

220-240V

White (WH12)

Model No.	Wattage (W)	Luminous Flux (lm)	Luminous Efficacy (lm/W)	Colour Temp. [CRI]	Beam Angle (°)	Dimension (mm)	Rated Life at L70B50 at Ta25°C (hrs)	Materials
FCL74200v0	12	1080 [3000K] 1200 [4000K, 6500K]	90 [3000K] 100 [4000K, 6500K]	3000K / 4000K / 6500K [≥80]	120	Ø220 x H40	25000	Plastic housing and Plastic diffuser
FCL74300v0	18	1620 [3000K] 1800 [4000K, 6500K]	90 [3000K] 100 [4000K, 6500K]	3000K / 4000K / 6500K [≥80]	120	Ø290 x H42	25000	Plastic housing and Plastic diffuser

FCL74200v0

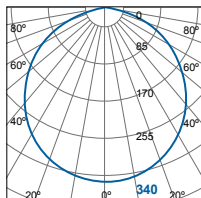

m	Lux	Ø cm
0.5	1360	173
1	340	346
1.5	151	520
2	85	693

Beam angle = 120°

FCL74300v0

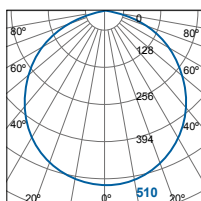

m	Lux	Ø cm
0.5	2040	173
1	510	346
1.5	227	520
2	128	693

Beam angle = 120°

Indoor Lighting / Bulkhead
MEGAMAN® KATIA

FCL74400v0

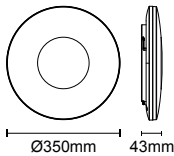

FCL74500v0

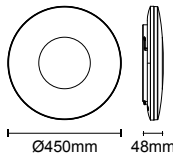

220-240V

White (WH12)

Model No.	Wattage (W)	Luminous Flux (lm)	Luminous Efficacy (lm/W)	Colour Temp. [CRI]	Beam Angle (°)	Dimension (mm)	Rated Life at L70B50 at Ta25°C (hrs)	Materials
FCL74400v0	24	2160 [3000K] 2400 [4000K, 6500K]	90 [3000K] 100 [4000K, 6500K]	3000K / 4000K / 6500K [≥80]	120	Ø350 x H43	25000	Plastic housing and Plastic diffuser
FCL74500v0	36	3240 [3000K] 3600 [4000K, 6500K]	90 [3000K] 100 [4000K, 6500K]	3000K / 4000K / 6500K [≥80]	120	Ø450 x H48	25000	Plastic housing and Plastic diffuser

FCL74400v0

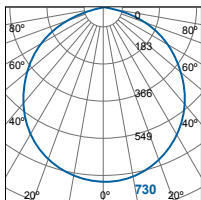

m	Lux	Ø cm
0.5	2920	173
1	730	346
1.5	324	520
2	183	693

Beam angle = 120°

FCL74500v0

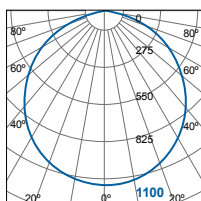

m	Lux	Ø cm
0.5	4400	173
1	1100	346
1.5	489	520
2	275	693

Beam angle = 120°



MEGAMAN® RENZOLITE

Integrated LED Bulkhead

MEGAMAN® RENZOLITE is a cost-effective sustainable bulkhead designed to replace traditional CFL ceiling lamp.

Features

- Delivers wide range of lumen packages for direct alternatives to traditional wall and ceiling
- Unobtrusive and understated design for all situations
- An evenly distributed light and visual comfort
- Durable PMMA cover avoid yellowish

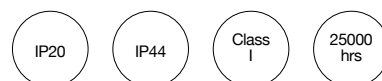

Applications

- Kitchens
- Corridors
- Residential

* IP44 For FCL72300v0



MEGAMAN® RENZOLITE

FCL72300v0

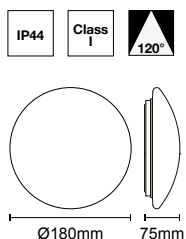
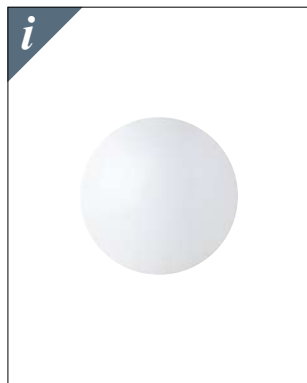

F50500SMv2

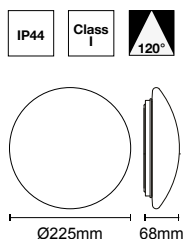

F50600SMv2

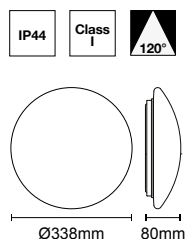

F50700SMv2

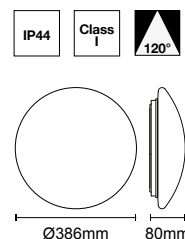

220-240V

White (WH126)

Model No.	Wattage (W)	Luminous Flux (lm)	Luminous Efficacy (lm/W)	Dimension (mm)	Colour Temp. [CRI]	Rated Life at L70 B50 at Ta25°C (hrs)	Materials
FCL72300v0	6	420	70	Ø180 x H75	3000K / 4000K / 6500K	25000	Metal Housing with PMMA cover
F50500SMv2	12	900	75	Ø225 x H68	3000K / 4000K / 6500K	25000	Metal Housing with PMMA cover
F50600SMv2	18	1350	75	Ø338 x H80	3000K / 4000K / 6500K	25000	Metal Housing with PMMA cover
F50700SMv2	24	1800	75	Ø386 x H80	3000K / 4000K / 6500K	25000	Metal Housing with PMMA cover

FCL72300v0

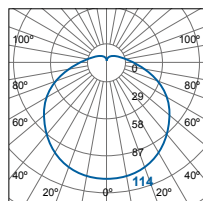

m	Lux	Ø cm
0.5	456	173
1	114	346
1.5	51	520
2	29	693

Beam angle = 120°

F50500SMv2

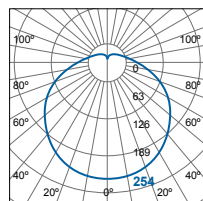

m	Lux	Ø cm
0.5	1016	173
1	254	346
1.5	113	520
2	64	693

Beam angle = 120°

F50600SMv2

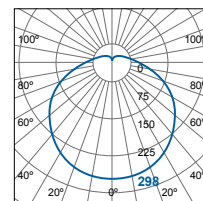

m	Lux	Ø cm
0.5	1192	173
1	298	346
1.5	132	520
2	75	693

Beam angle = 120°

F50700SMv2

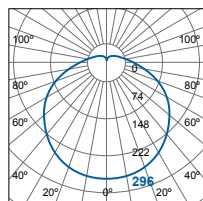

m	Lux	Ø cm
0.5	1184	173
1	296	346
1.5	132	520
2	74	693

Beam angle = 120°

MEGAMAN® MILENA PRO



NEW



MEGAMAN® MILENA PRO



MEGAMAN® MILENA PRO

LED Downlight

MEGAMAN® MILENA PRO integrated LED downlight comes with low glare (UGR \leq 19) control in faceted reflector offering maximum visual comfort and low flicker (\leq 8%) to avoid eye fatigue. It delivers uniformity of light distribution. MEGAMAN® MILENA PRO is the perfect solution for the ceiling recess mounting allows retrofit for conventional downlights in existing cut-outs.

Features

- Offer high cut-off angle for low glare (UGR \leq 19) control in faceted reflector
- Terminal block facilitate easy installation and maintenance, and through wiring possible
- Two sizes allow retrofit for many conventional downlights in existing ceiling cut-outs
- Low flicker \leq 8% to avoid eye fatigue
- Delivery of uniform light distribution
- IP54 rated for damp locations such as bathroom and kitchen
- Operating temperature from -30°C to +40°C

UGR
 \leq 19

IP54

50000
hrs

Applications

- Offices
- Retail
- Bathrooms
- Hotels
- Kitchens
- Restaurants

Wiring Diagram

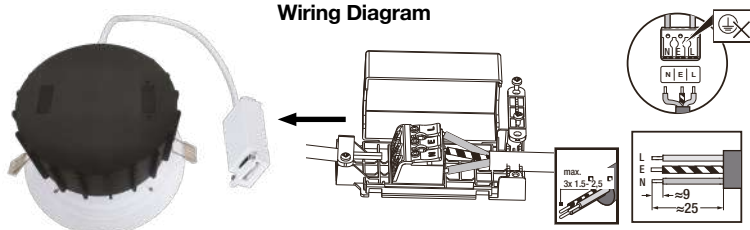

MEGAMAN® MILENA PRO

FDL75700v0



FDL75800v0



UGR ≤19 IP54

UGR ≤19 IP54

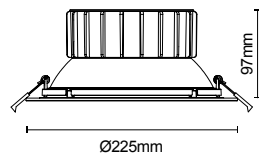
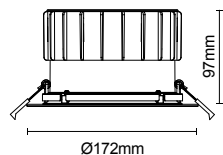

220-240V

White (WH26)

Model No.	System Wattage (W)	Luminous Flux (lm)	System Luminous Efficacy (lm/W)	Beam Angle (°)	Dimension (mm)	Cut-Out (mm)	Colour Temp.	CRI	Rated Life at L80 B10 at Ta25°C (hrs)	Power Factor (λ)	Materials
FDL75700v0	18	1650 [3000K] 1800 [4000K]	92 [3000K] 100 [4000K]	60	Ø172 x H97	Ø150	3000K/4000K	≥80	50000	>0.9	Aluminum & PC
FDL75800v0	23	2150 [3000K] 2300 [4000K]	93 [3000K] 100 [4000K]	60	Ø255 x H97	Ø200	3000K/4000K	≥80	50000	>0.9	Aluminum & PC

FDL75700v0

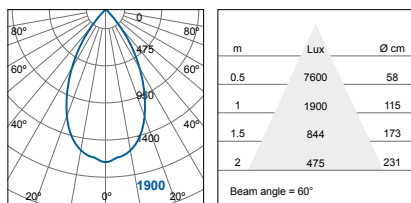

FDL75800v0

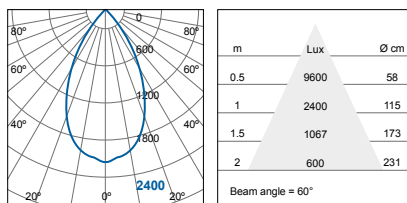

MEGAMAN® MILENA PRO



MEGAMAN® MILENA



MEGAMAN® MILENA



MEGAMAN® MILENA

Modular LED Downlight

MEGAMAN® MILENA is a modular downlight unit consisting of dual-lumen output & dual-CCT LED light engine, various metal housing and reflector or diffuser options, allowing tool-less assembly in-situ. The luminaire offers maximum visual comfort by high cut-off angle for better glare control and low flicker to avoid eye fatigue.

Features

- Modular downlight unit consist of dual-lumen output & dual-CCT LED light engine, reflector or diffuser module
- The modular components design allow the assembly in-situ without any tool
- Inter-changeable light engine between 6" and 8" luminaire
- The flexibility modular design enables a faster delivery period for customized requirements, which is an ideal solution for short lead time projects
- Offer high cut-off angle for better glare control
- Tool-less terminal block up to 3 x 2.5mm² facilitate easy installation and maintenance, and through wiring possible
- Wide range of sizes allow retrofit for many conventional downlights in existing ceiling cut-outs
- Delivery of wide and uniform light distribution
- Flicker free to avoid eye fatigue
- IP54 rated for damp location such as bathroom and kitchen

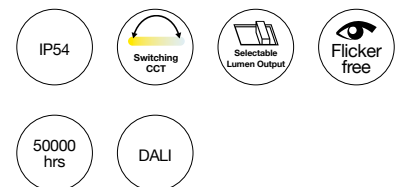

Applications

- Retails
- Bathrooms
- Hotels
- Kitchens
- Offices
- Restaurants

MEGAMAN® MILENA



Low output / High output



Switching CCT (3000K/4000K)



The modular design allows tool-less assembly



3 x 2.5mm² tool-less terminal block



MEGAMAN® MILENA FR

FDM70600v0-ds/sc



4"

FDL71300v0-ds/sc
FDL71300v1-ds/sc
FDL71300v2-ds/sc



6"

FDL71500v0-ds/sc
FDL71500v1-ds/sc



8"



Ø130mm



Ø172mm



Ø225mm

220-240V White (WH26)

Reflector | ON/OFF Version

Model No.	Wattage (W)	Luminous Flux (lm)	System Luminous Efficacy (lm/W)	Beam Angle (°)	Dimension (mm)	Cut-Out (mm)	Colour Temp. [CRI]	Rated Life at L80 B10 at Ta25°C (hrs)	Power Factor (λ)	Materials
ON/OFF Version										
FDM70600v0-ds/sc	6.5/9	600/830 [3000K] 650/900 [4000K]	92/92 [3000K] 100/100 [4000K]	90	Ø130 x H87	Ø100	3000K/4000K Switchable	50000	>0.9	Aluminum & PC
FDL71300v0-ds/sc	10/16	930/1450 [3000K] 1000/1600 [4000K]	93/91 [3000K] 100/100 [4000K]	90	Ø172 x H87	Ø150	3000K/4000K Switchable	50000	>0.9	Aluminum & PC
FDL71300v1-ds/sc	18/23	1670/2230 [3000K] 1800/2400 [4000K]	97/93 [3000K] 104/100 [4000K]	90	Ø172 x H87	Ø150	3000K/4000K Switchable	50000	>0.9	Aluminum & PC
FDL71300v2-ds/sc	19.5/25	1860/2500 [3000K] 2000/2700 [4000K]	100/95 [3000K] 108/103 [4000K]	90	Ø172 x H87	Ø150	3000K/4000K Switchable	50000	>0.9	Aluminum & PC
FDL71500v0-ds/sc	18/23	1670/2230 [3000K] 1800/2400 [4000K]	97/93 [3000K] 104/100 [4000K]	90	Ø225 x H97	Ø200	3000K/4000K Switchable	50000	>0.9	Aluminum & PC
FDL71500v1-ds/sc	19.5/25	1860/2500 [3000K] 2000/2700 [4000K]	100/95 [3000K] 108/103 [4000K]	90	Ø225 x H97	Ø200	3000K/4000K Switchable	50000	>0.9	Aluminum & PC

Light Engine Module (NON-DIM)



LA3240
4" Light engine module
650/900lm



LA3242
6"/8" Light engine module
1000/1600lm



LA3243
6"/8" Light engine module
1800/2400lm



LA3244
6"/8" Light engine module
2000/2700lm

Bezel



LA3135
4" Facet Reflector Bezel



LA3136
6" Facet Reflector Bezel



LA3137
8" Facet Reflector Bezel



LA3138
4" Diffuser Bezel



LA3139
6" Diffuser Bezel



LA3140
8" Diffuser Bezel

MEGAMAN® MILENA FR

FDL71300v2-ex/sc



IP20 / IP54 Class II Flicker Free

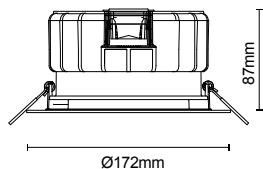

FDL71500v1-ex/sc



IP20 / IP54 Class II Flicker Free

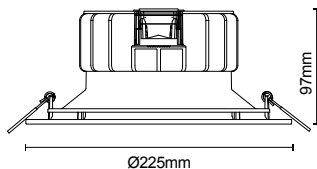

220-240V

White (WH26)

Reflector | DALI Version

Model No.	Wattage (W)	Luminous Flux (lm)	System Luminous Efficacy (lm/W)	Beam Angle (°)	Dimension (mm)	Cut-Out (mm)	Colour Temp. [CRI]	Rated Life at L80 B10 at Ta25°C (hrs)	Power Factor (λ)	Materials
DALI Version										
FDL71300v0-ex/sc +LD232037/da/mc-C0950	23.2	2500 [3000K] 2700 [4000K]	107 [3000K] 116 [4000K]	90	Ø172 x H87	Ø150	3000K/4000K Switchable	50000	>0.9	Aluminum & PC
FDL71500v0-ex/sc +LD232037/da/mc-C0950	23.2	2500 [3000K] 2700 [4000K]	107 [3000K] 116 [4000K]	90	Ø225 x H97	Ø200	3000K/4000K Switchable	50000	>0.9	Aluminum & PC

Light Engine Module (NON-DIM)



LA3242
6"/8" Light engine module
1000/1600lm

Bezel



LA3136
6" Facet Reflector Bezel



LA3137
8" Facet Reflector Bezel



LA3138
4" Diffuser Bezel



LA3139
6" Diffuser Bezel



LA3140
8" Diffuser Bezel

MEGAMAN® MILENA

FDM70700v0-ds/sc



IP20 / IP54 Class II Flicker Free

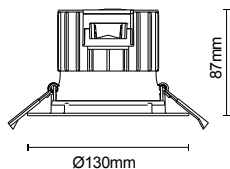

FDL71400v0-ds/sc
FDL71400v1-ds/sc
FDL71400v2-ds/sc



IP20 / IP54 Class II Flicker Free

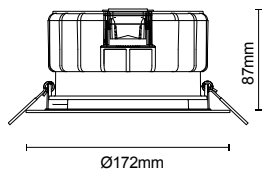

FDL71600v0-ds/sc
FDL71600v1-ds/sc



IP20 / IP54 Class II Flicker Free

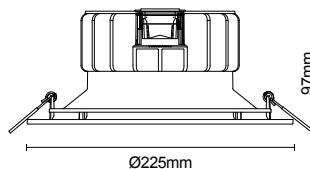

220-240V

White (WH26)

Diffuser | ON/OFF Version

Model No.	Wattage (W)	Luminous Flux (lm)	System Luminous Efficacy (lm/W)	Beam Angle (°)	Dimension (mm)	Cut-Out (mm)	Colour Temp. [CRI]	Rated Life at L80 B10 at Ta25°C (hrs)	Power Factor (λ)	Materials
ON/OFF Version										
FDM70700v0-ds/sc	6.5/9	560/770 [3000K] 600/830 [4000K]	86/92 [3000K] 86/92 [4000K]	100	Ø130 x H87	Ø100	3000K/4000K Switchable	50000	>0.9	Aluminum & PC
FDL71400v0-ds/sc	10/16	930/1450 [3000K] 1000/1600 [4000K]	93/91 [3000K] 100/100 [4000K]	100	Ø172 x H87	Ø150	3000K/4000K Switchable	50000	>0.9	Aluminum & PC
FDL71400v1-ds/sc	18/23	1670/2230 [3000K] 1800/2400 [4000K]	93/93 [3000K] 100/100 [4000K]	100	Ø172 x H87	Ø150	3000K/4000K Switchable	50000	>0.9	Aluminum & PC
FDL71400v2-ds/sc	19.5/25	1860/2500 [3000K] 2000/2700 [4000K]	93/93 [3000K] 100/100 [4000K]	100	Ø172 x H87	Ø150	3000K/4000K Switchable	50000	>0.9	Aluminum & PC
FDL71600v0-ds/sc	18/23	1670/2230 [3000K] 1800/2400 [4000K]	93/93 [3000K] 100/100 [4000K]	100	Ø225 x H97	Ø200	3000K/4000K Switchable	50000	>0.9	Aluminum & PC
FDL71600v1-ds/sc	19.5/25	1860/2500 [3000K] 2000/2700 [4000K]	93/93 [3000K] 100/100 [4000K]	100	Ø225 x H97	Ø200	3000K/4000K Switchable	50000	>0.9	Aluminum & PC

Light Engine Module (NON-DIM)



LA3240
4" Light engine module
650/900lm



LA3242
6"/8" Light engine module
1000/1600lm



LA3243
6"/8" Light engine module
1800/2400lm



LA3244
6"/8" Light engine module
2000/2700lm

Bezel



LA3135
4" Facet Reflector Bezel



LA3136
6" Facet Reflector Bezel



LA3137
8" Facet Reflector Bezel



LA3138
4" Diffuser Bezel



LA3139
6" Diffuser Bezel



LA3140
8" Diffuser Bezel

MEGAMAN® MILENA

FDL71400v2-ex/sc



IP20 / IP54 | Class II | Flicker Free | DALI

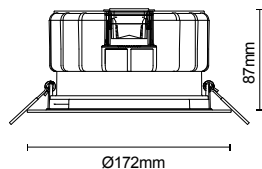

FDL71600v1-ex/sc



IP20 / IP54 | Class II | Flicker Free | DALI

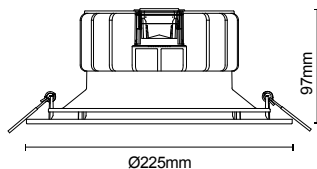

220-240V

White (WH26)

Diffuser | DALI Version

Model No.	System Wattage (W)	Luminous Flux (lm)	System Luminous Efficacy (lm/W)	Beam Angle (°)	Dimension (mm)	Cut-Out (mm)	Colour Temp. [CRI]	Rated Life at L80 B10 at Ta25°C (hrs)	Power Factor (λ)	Materials
DALI Version										
FDL71400v0-ex/sc +LD232037/da/mc-C0950	23.2	2320 [3000K] 2500 [4000K]	100 [3000K] 107 [4000K]	100	Ø172 x H87	Ø150	3000K/4000K Switchable	50000	>0.9	Aluminum & PC
FDL71600v0-ex/sc +LD232037/da/mc-C0950	23.2	2320 [3000K] 2500 [4000K]	100 [3000K] 107 [4000K]	100	Ø225 x H97	Ø200	3000K/4000K Switchable	50000	>0.9	Aluminum & PC

Light Engine Module (NON-DIM)



LA3242
6"/8" Light engine module
1000/1600lm

Bezel



LA3136
6" Facet Reflector Bezel



LA3137
8" Facet Reflector Bezel



LA3138
4" Diffuser Bezel



LA3139
6" Diffuser Bezel



LA3140
8" Diffuser Bezel

MEGAMAN® MILENA



MEGAMAN® RICO HR



MEGAMAN® RICO HR



MEGAMAN® RICO HR

Ultra Slim LED Downlight

In response to the market needs for ultra slim LED downlight, MEGAMAN® RICO HR is the perfect solution for the ceiling recess with limited depth. MEGAMAN® RICO HR is designed for optimal lighting performance, great functionality and consistency in design. The cut-out is 68 mm, as well as the standard 36° beam angle and adjustable 25° tilting angle. The luminaire is suitable for various kinds of applications.

Features:

- Ideal for any ceiling recess with limited path
- Suitable for small cabinets and furniture lighting where space is restricted
- Uses an external driver with industry standard constant current levels
- Compatible with a wide range of drivers available on the market
- Allows use with standard dimming drivers such as DALI, DSL or 1-10V for linear dimming
- IP44 protection enables the use in humid and damp areas such as bathrooms or kitchens
- Minimizes storage and transportation costs



Applications

- Shops
- Offices
- Hotels
- Corridors
- Shopping malls
- Workstations
- Study rooms
- Display shelves
- Kitchen cabinets and counters
- Bathrooms
- Wardrobes

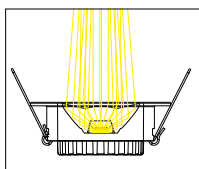

The latest MEGAMAN® Hybrid Reflector technology delivers excellent optical efficacy, better beam control and less spill light

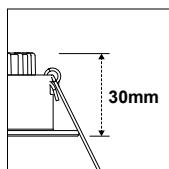

Designed with a height of only 30mm, making it ideal for limited recess depths

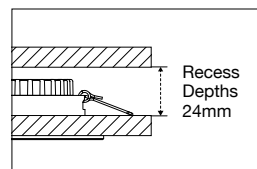

Ultra-Low Profile version together with extra small drivers are now available, perfect for limited recess depths with only 24mm, such as furniture and cabinet lightings

MEGAMAN® RICO HR

F53500RC / F53500RCv2

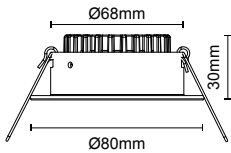
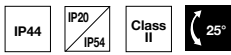

F53500RC-w/ru

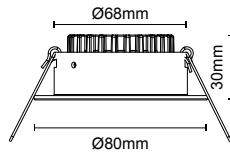

DC16-21V



Standard Version

Model No.	Input Current (mA)	Wattage (W)	Luminous Flux (lm)	Luminous Efficacy (lm/W)	Beam Angle (°)	Max. Luminous Intensity (cd)	Dimension (mm)	Cut-Out (mm)	Colour Temp. [CRI]	Rated Life at L70 B50 at Ta25°C (hrs)	Dimmable	Materials	Suggested Driver
F53500RC	350	6.5	500	77	36	1100	Ø80 x H30	Ø68	2800K / 4000K [>Ra80]	25000	Dimmable ²	Metal housing with hybrid reflector	LD0509x1d-C350
F53500RC-w/ru	350	6.5	500	77	36	1100	Ø80 x H30	Ø68	3000K-1800K [>Ra80]	50000	Dimmable ² (3000K-1800K)	Metal housing with hybrid reflector	LD0509x1d-C350
F53500RCv2	500	9	900	100	36	2400	Ø80 x H30	Ø68	2800K / 4000K [>Ra80]	50000 ¹	Dimmable ²	Metal housing with hybrid reflector	LD0512x1d-C500

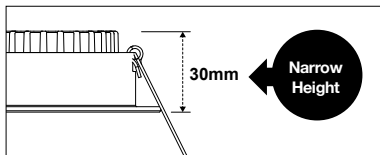

U-DIM™

Compatible with BOTH Leading-edge and Trailing-edge Conventional Dimmers for 100-5% Linear Dimming

when MEGAMAN® RICO HR working with MEGAMAN® drivers LD0509x1d-C350 and LD0512x1d-C500

F53500RC

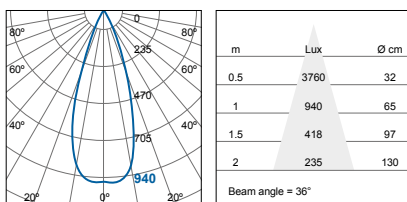

F53500RC-w/ru

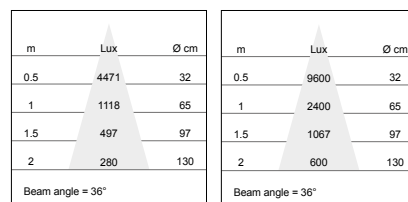

F53500RCv2

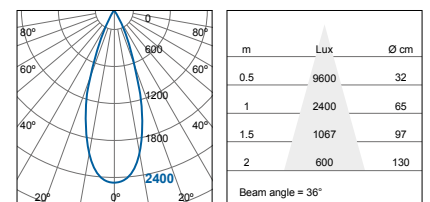

External driver with output current and nominal voltage corresponding to the input current and nominal voltage of the luminaire is required. For example, the external driver with output current of 350mA and nominal voltage of DC16-21V is required for F53500RC.

¹ The rated life of F53500RC-w/ru and F53500RCv2 is 50,000hrs at L80B50@Ta25°C and L70B50@Ta25°C respectively.

² Capable of linear dimming when working with DALI, DSI or 1-10V dimming drivers, and the dimming performance depends on the specification of driver.

MEGAMAN® RICO HR

F62300RC-r9 / F62300RCv1-r9

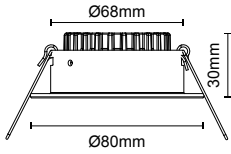
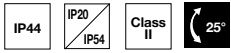

F62300RC-w/ru

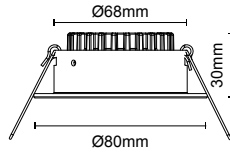
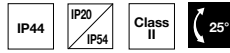

DC15-19V



Ultra-Low Profile Version

Model No.	Input Current (mA)	Wattage (W)	Luminous Flux (lm)	Luminous Efficacy (lm/W)	Beam Angle (°)	Max. Luminous Intensity (cd)	Dimension (mm)	Cut-Out (mm)	Colour Temp. [CRI]	Rated Life at L70 B50 at Ta25°C (hrs)	Dimmable	Materials	Suggested Driver
F62300RC-r9 Ra95	350	6.5	500	77	36	1100	Ø80 x H30	Ø68	2800K / 4000K [>Ra95]	25000	Dimmable ²	Metal housing with hybrid reflector	LD0509x1d-C350
F62300RCv1-r9 Ra95	500	9	700	78	36	1650	Ø80 x H30	Ø68	2800K / 4000K [>Ra95]	25000	Dimmable ²	Metal housing with hybrid reflector	LD0509x1d-C350
F62300RC-w/ru 	350	6	500	83	36	1100	Ø80 x H30	Ø68	3000K-1800K [>Ra97]	50000	Dimmable ² (3000K-1800K)	Metal housing with hybrid reflector	LD0509x1d-C350

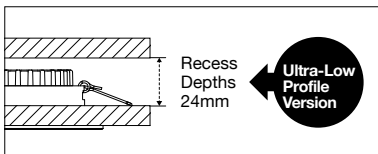

U-DIM™
Compatible with BOTH Leading-edge and Trailing-edge Conventional Dimmers for 100-5% Linear Dimming
when MEGAMAN® RICO HR working with MEGAMAN® drivers LD0509x1d-C350 and LD0512x1d-C500

F62300RC-r9

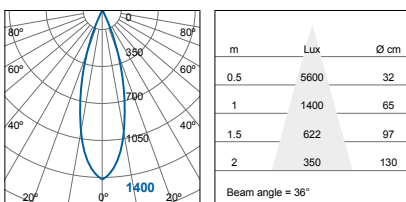

F62300RCv1-r9

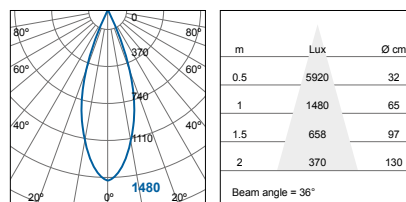

F62300RC-w/ru

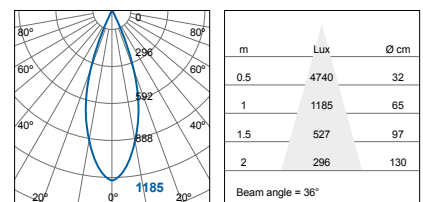

External driver with output current and nominal voltage corresponding to the input current and nominal voltage of the luminaire is required. For example, the external driver with output current of 350mA and nominal voltage of DC16-21V is required for F53500RC.

¹ The rated life of F53500RC-w/ru and F62300RCv2 is 50000hrs at L70 B50 at Ta25°C

² Capable of linear dimming when working with DALI, DSI or 1-10V dimming drivers, and the dimming performance depends on the specification of driver.



MEGAMAN® TEGO

Fire Rated LED Downlight

MEGAMAN® TEGO provides fire protection that protects the integrity of the ceiling and prevents the spread of fire and smoke into the room above. MEGAMAN TEGO is compliant to BS476 Part 21 and is designed to withstand fire for up to 30, 60 and 90 minutes.

With features of easy installation and stock management, this series provides flexibility and convenience at the same time with thoughtful design.

Features

- Fully compliant to the building regulations requirement "Approved Document B" and fire tested in accordance with BS476-21
- Fully Fire-rated for 30, 60 and 90 minute ceilings
- IP65 version allows to use in bathroom
- Integrated version enhance easy installation and wiring
- Unique tool-less wiring block and push-in terminal ensure easy installation
- Loop in/Loop out feature enable one to one quick connection
- Robust spring clip
- Triac dimmable as standard
- Up to 88 lm/W
- 3000K and 4000K colour temperature switching in-situ
- Interchangeable bezel with 3 finishing (White, Chrome & Brush Nickel) enable flexibility of stock

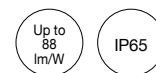

Applications

- Restaurants
- Hotels
- Offices
- Kitchens
- Corridors

Indoor Lighting / Downlight

MEGAMAN® TEGO

FDS71900v0-dm/sc
FDS72000v0-dm/sc
FDS72100v0-dm/sc

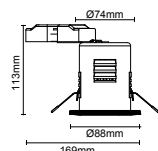

220-240V

White (WH12)

Model No.	Wattage (W)	Luminous Flux (lm)	Beam Angle (°)	Dimension (mm)	Cut-Out (mm)	Colour Temp* (CCT Switching)	CRI	Rated Life at L70 B50 at Ta25°C (hrs)	IP Rating	Dimmable *Triac	Materials	Remarks
FDS71900v0-dm/sc	5	420	36	Ø85 x H70	Ø73	3000K/ 4000K	≥80	30,000	IP65	100-10%	Steel + Plastic	Fixed
FDS72000v0-dm/sc	5	420	36	Ø85 x H70	Ø73	3000K/ 4000K	≥80	30,000	IP20	100-10%	Steel + Plastic	Adjustable
FDS72100v0-dm/sc	7.5	630	36	Ø85 x H70	Ø73	3000K/ 4000K	≥80	30,000	IP65	100-10%	Steel + Plastic	Fixed

FDS71900v0-dm/sc
FDS72000v0-dm/sc

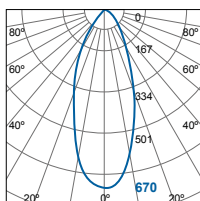

m	Lux	Ø cm
0.5	2680	32
1	670	65
1.5	298	97
2	168	130

Beam angle = 36°

FDS72100v0-dm/sc

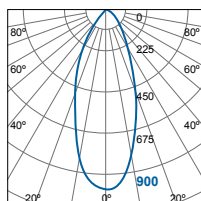

m	Lux	Ø cm
0.5	3600	32
1	900	65
1.5	400	97
2	225	130

Beam angle = 36°

Accessory



LA10130/CH
Bezel in CH
(Fixed)



LA10130/BN
Bezel in BN
(Fixed)



LA10131/CH
Bezel in CH
(Adjustable)



LA10131/BN
Bezel in BN
(Adjustable)



MEGAMAN® TEGO 2



MEGAMAN® TEGO 2

Integrated LED Downlight

MEGAMAN® TEGO 2 integrated LED downlight comes with the Dual Beam Technology which offers a flexible choice of two beam angles in one luminaire. Switching CCT as well as dimmable function provides flexibility and convenience at the same time with thoughtful design. MEGAMAN® TEGO 2 with features of easy installation and stock management.

Features

- MEGAMAN® Dual Beam Technology (DBT) downlight, two beam angles in one fitting, 36° & 60°
- Dual CCT 2800K & 4000K and can be switched by tuning the front bezel
- Both beam angle and CCT can be changed in-situ, according to lighting requirements
- Universal dimming (U-dim) caters both leading edge and trailing edge dimmer with linear performance
- IP54 rated perfect to use in moisture area, e.g. bathroom
- 5 front covers option (White, Chrome, Brushed Nickel, Matt Black and Gold) available & can be interchanged
- Long lifetime 50,000hrs L80B10
- Tool-less wiring installation with loop in/loop out function
- Flicker free
- Ideal replacement for 75W halogen lamp



Applications

- Restaurants
- Hotels
- Offices
- Kitchens
- Corridors

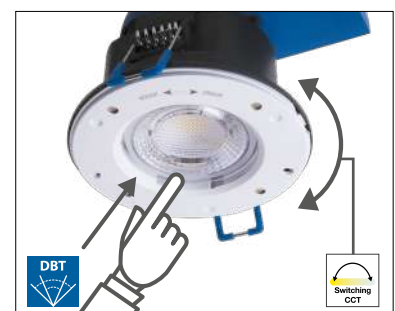

Indoor Lighting / Downlight

MEGAMAN® TEGO 2

FDS72300v0-dm/db/sc

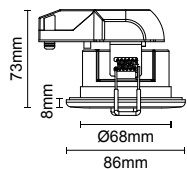
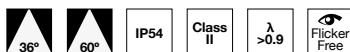

220-240V



Model No.	Wattage (W)	Luminous Flux (lm)	Lm/W	Beam Angle (°)	CD	Dimension (mm)	Cut-Out (mm)	Colour Temp.	CRI	Rated Life at L80 B10 at Ta40°C (hrs)	Dimmable	Materials
FDS72300v0-dm/db/sc	7.5	600 [2800K] 650 [4000K]	80 [2800K] 87 [4000K]	36/60	960 [36°] 665 [60°]	Ø80 x H72	Ø68	2800K/4000K Switchable	≥80	50000	Universal dimming	Plastic Housing + Metal

FDS72300v0-dm/db/sc-36°

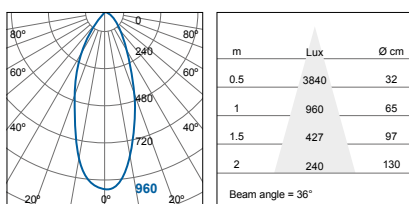

FDS72300v0-dm/db/sc-60°

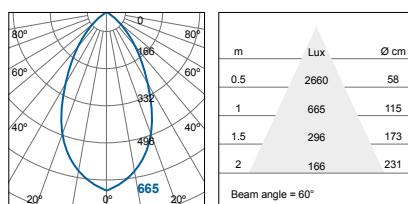

Accessory



LA8085/WH
Bezel
(White)

LA8085/CH
Bezel
(Chrome)

LA8085/NI
Bezel
(Brush Nickel)

LA8085/BK
Bezel
(Matt Black)

LA8085/GD
Bezel
(Gold)



Interchangeable bezel with 5 finishing (White, Chrome, Brushed Nickel, Matt Black & Gold) enable flexibility of stock

MEGAMAN® TEGO 2 FRD



MEGAMAN® TEGO 2 FRD

Fire-rated LED Downlight

MEGAMAN® TEGO 2 FRD provides fire protection that protects the integrity of the ceiling and prevents the spread of fire and smoke into the room above. MEGAMAN® TEGO 2 FRD complies to BS476 Part 21 and is designed to withstand fire for up to 30, 60 and 90 minutes. MEGAMAN® TEGO 2 FRD comes with the Dual Beam Technology (DBT) which offers a flexible choice of two beam angles in one luminaire, switching CCT, as well as a dimmable function provides the flexibility and convenience at the same time with thoughtful design.

Features

- Fire-rated, achieved BS 476-20:1987+AC:2014 -Part 20 and BS 476-21:1987+AC:2014 -Part 20 Part 21, ≥30mins, ≥60mins, ≥90mins.
- MEGAMAN® Dual Beam Technology (DBT) downlight, two beam angles in one fitting, 36° & 60°
- Dual CCT 2800K & 4000K and can be switched by tuning the front bezel
- Both beam angle and CCT can be changed in-situ, according to lighting requirements
- Universal dimming (U-dim) caters both leading edge and trailing edge dimmer with linear performance
- IP65 rated perfect to use in moisture area, e.g. bathroom
- 5 front cover options are (White, Chrome, Brushed Nickel, Matt Black and Gold) available and interchangeable
- Long lifetime 50,000hrs L80B10
- Tool-less wiring installation with loop in/loop out function
- Flicker free
- Ideal replacement for 75W halogen lamp

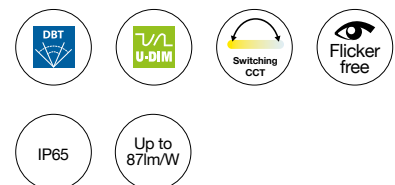

Applications

- Restaurants
- Hotels
- Offices
- Kitchens
- Corridors



MEGAMAN® TEGO 2 FRD

FDS72400v0-dm/db/sc

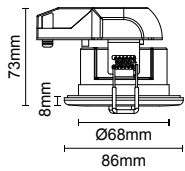
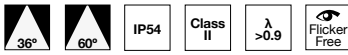

220-240V



Model No.	Wattage (W)	Luminous Flux (lm)	Lm/W	Beam Angle (°)	CD	Dimension (mm)	Cut-Out (mm)	Colour Temp.	CRI	Rated Life at L80 B10 at Ta25°C (hrs)	Dimmable	Materials
FDS72400v0-dm/db/sc	7.5	600 [2800K] 650 [4000K]	80 [2800K] 87 [4000K]	36/60	1400 [36°] 650 [60°]	Ø90 x H72	Ø68	2800K/4000K Switchable	≥80	50000	Universal dimming	Plastic Housing + Metal

FDS72400v0-dm/db/sc-36°

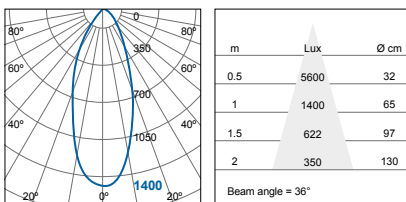

FDS72400v0-dm/db/sc-60°

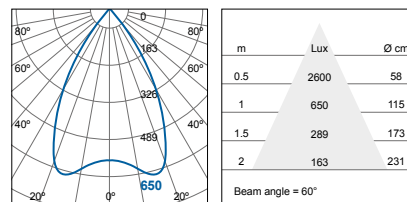

Accessory



LA8111/WH
Bezel
(White)

LA8111/CH
Bezel
(Chrome)

LA8111/NI
Bezel
(Brush Nickel)

LA8111/BK
Bezel
(Matt Black)

LA8111/GD
Bezel
(Gold)



MEGAMAN® TEGO 3



MEGAMAN® TEGO 3

Integrated LED Downlight

MEGAMAN® TEGO 3 integrated LED downlight comes with the Dual Beam Technology with offers a flexibility choice of two beam angles in one luminaire. Switching CCT as well as dimmable function provided flexibility and convenience at the same time with smart design. Optional thermal insulation guard available for using under thermal ceiling installation.

Features

- MEGAMAN® Dual Beam Technology (DBT) downlight, two beam angles (36° & 60°) in one fitting
- Dual CCT 2800K & 4000K and can be switched by tuning the lens
- Both beam angle and CCT can be changed in-situ, according to lighting requirements
- Universal dimming with smooth performance
- IP54 rated perfect to use in moisture area, e.g. bathroom
- Optional thermal insulation guard available for using under thermal ceiling installation
- Optional 5 finishing bezels (White, Black, Gold, Chrome & Brushed Nickel) available & can be easily interchanged
- Long lifetime 50,000hrs L70B50 @ Ta25°C
- Tool-less wiring installation with loop in/loop out function

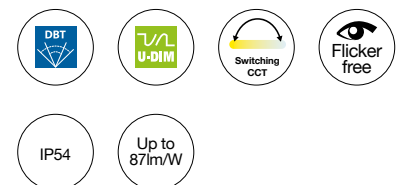

Applications

- Restaurants
- Hotels
- Offices
- Kitchens
- Corridors



Indoor Lighting / Downlight

MEGAMAN® TEGO 3

FDS73200v0-dm/db/sc+036D060D

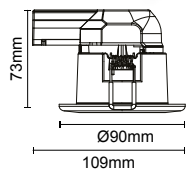
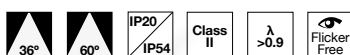

Model No.	Wattage (W)	Luminous Flux (lm)	Lm/W	Beam Angle (°)	CD	Dimension (mm)	Cut-Out (mm)	Colour Temp.	CRI	Rated Life at L70 B50 at Ta25°C (hrs)	Dimmable	Materials
FDS73200v0-dm/db/sc+036D060D	7.5	600 [2800K] 650 [4000K]	80 [2800K] 87 [4000K]	36/60	1300 [36°] 650 [60°]	Ø90 x 109 x 73	Ø68	2800K/4000K Switchable	≥80	50000	Universal dimming	Plastic housing and Plastic diffuser

FDS73200v0-dm/db/sc+36°

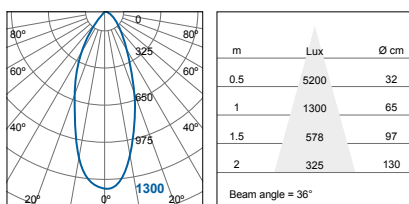

FDS73200v0-dm/db/sc+60°

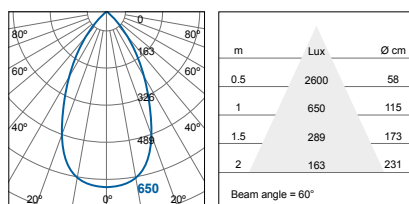

Accessory



LA8111/WH Bezel (White) | LA8111/CH Bezel (Chrome) | LA8111/NI Bezel (Brushed Nickel) | LA8111/BK Bezel (Matt Black) | LA8111/GD Bezel (Gold)





MEGAMAN® TEGO SLIM

Fire Rated LED Downlight

MEGAMAN® TEGO SLIM provides fire protection that protects the integrity of the ceiling and prevents the spread of fire and smoke into the room above. MEGAMAN® TEGO SLIM is compliant to BS476 Part 21 and is designed to withstand fire for up to 30, 60 and 90 minutes. MEGAMAN® TEGO SLIM is a full fire-rated downlight comes with Universal dimming which caters both leading edge and trailing edge dimmer with linear dimming performance also with features of easy installation and stock management.

Features

- Fully comply to the building regulations requirement "Approved Document B" and fire tested in accordance with BS476-21
- Full fire-rated for 30, 60 and 90 minutes ceilings
- IP65 rated perfect to use in moisture area, e.g. bathroom
- Compact and Slim design, ideal for ceiling with limited depth
- Universal dimming (U-dim) caters both leading edge and trailing edge dimmer with linear dimming performance
- Flexible cord between luminaire and terminal block that facilitates easy installation
- Optional thermal insulation guard available for using under thermal ceiling installation
- Tool-less wiring installation with loop in/loop out quick connection
- Interchangeable bezel with 3 finishing (White, Chrome and Brushed Nickel) enable stock flexibility



Applications

- Conference rooms
- Shops
- Restaurants
- Hotels
- Offices
- Corridors



MEGAMAN® TEGO SLIM

FDS73100v0-dm

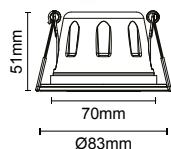
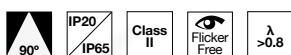

FDS73100v0-dm-N152

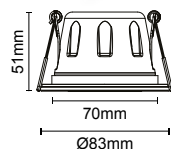
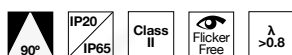

FDS73100v0-dm-CH53

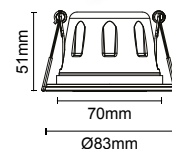
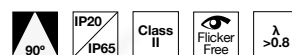

220-240V

White (WH1) Chrome (CH53) Brushed Nickel (NI52)

Model No.	Wattage (W)	Luminous Flux (lm)	Beam Angle (°)	Dimension (mm)	Cut-Out (mm)	Colour Temp.	Rated Lifetime L70B50@Ta25°C (hrs)	Materials
FDS73100v0-dm	5.5	450	90	Ø83 x 51	Ø70	2800K / 4000K	25000	Metal + Plastic housing Plastic diffuser
FDS73100v0-dm-N152	5.5	450	90	Ø83 x 51	Ø70	2800K / 4000K	25000	Metal + Plastic housing Plastic diffuser
FDS73100v0-dm-CH53	5.5	450	90	Ø83 x 51	Ø70	2800K / 4000K	25000	Metal + Plastic housing Plastic diffuser

FDS73100v0-dm

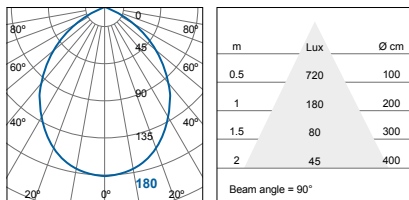

Accessories



LA8125
Thermal insulation guard

MEGAMAN® KANA



MEGAMAN® KANA



MEGAMAN® KANA

Integrated LED Downlight

MEGAMAN® KANA is a cost-effective sustainable downlight solution designed to replace traditional CFL downlights. Featuring LED technology allows further energy-saving and uniform light distribution. MEGAMAN® KANA with a compact design which suitable for limited ceiling depths installation.

Features

- Replacement for traditional CFL downlights
- No external driver required which facilitates easy installation and maintenance
- Delivers uniform light distribution
- Range of sizes allowing retrofit for many conventional downlights in existing ceiling cut-outs
- Slim design suitable for limited ceiling depths

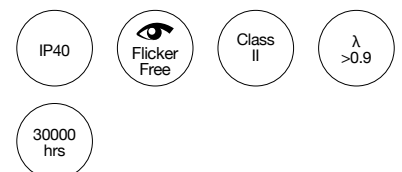

Applications

- Retails
- Bathrooms
- Hotels
- Kitchens
- Offices
- Restaurants

MEGAMAN® KANA

FDM72300v0



IP40 Class II Flicker Free

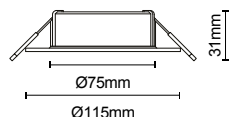

FDL74600v0



IP40 Class II Flicker Free

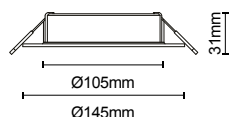

FDL74700v0



IP40 Class II Flicker Free

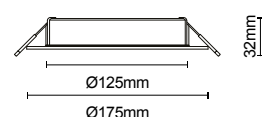

220-240V

White (WH12)

Model No.	Wattage (W)	Luminous Flux (lm)	Beam Angle (°)	Power Factor (λ)	Dimension (mm)	Cutout (mm)	Colour Temp. [CRI]	Rated Life at L70B50 at Ta25°C (hrs)	Materials
FDM72300v0	7	530 [3000K] 560 [4000K]	120	>0.9	Ø115 x H31	Ø75-90	3000K / 4000K [≥80]	30000	Plastic housing + PS diffuser
FDL74600v0	10	760 [3000K] 800 [4000K]	120	>0.9	Ø145 x H31	Ø105-125	3000K / 4000K [≥80]	30000	Plastic housing + PS diffuser
FDL74700v0	13	990 [3000K] 1040 [4000K]	120	>0.9	Ø175 x H32	Ø125-150	3000K / 4000K [≥80]	30000	Plastic housing + PS diffuser

FDM72300v0

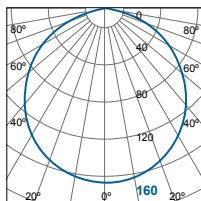

m	Lux	Ø cm
0.5	640	173
1	160	346
1.5	71	520
2	40	693

Beam angle = 120°

FDL74600v0

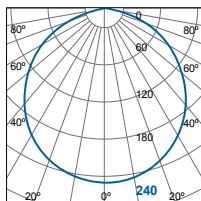

m	Lux	Ø cm
0.5	960	173
1	240	346
1.5	107	520
2	60	693

Beam angle = 120°

FDL74700v0

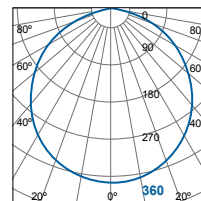

m	Lux	Ø cm
0.5	1440	173
1	360	346
1.5	160	520
2	90	693

Beam angle = 120°

MEGAMAN® KANA

FDL74800v0



IP40 Class II Flicker Free

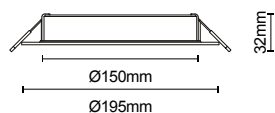

FDL74900v0



IP40 Class II Flicker Free

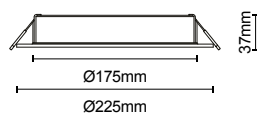

220-240V

White (WH12)

Model No.	Wattage (W)	Luminous Flux (lm)	Beam Angle (°)	Power Factor (λ)	Dimension (mm)	Cutout (mm)	Colour Temp. [CRI]	Rated Life at L70B50 at Ta25°C (hrs)	Materials
FDL74800v0	19	1440 [3000K] 1520 [4000K]	120	>0.9	Ø195 x H32	Ø150-175	3000K / 4000K [≥80]	30000	Plastic housing + PS diffuser
FDL74900v0	25	1900 [3000K] 2000 [4000K]	120	>0.9	Ø225 x H37	Ø175-200	3000K / 4000K [≥80]	30000	Plastic housing + PS diffuser

FDL74800v0

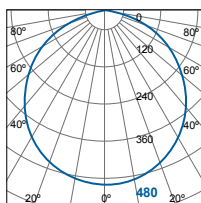

m	Lux	Ø cm
0.5	1920	173
1	480	346
1.5	213	520
2	120	693

Beam angle = 120°

FDL74900v0

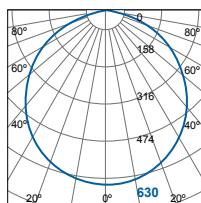

m	Lux	Ø cm
0.5	2520	173
1	630	346
1.5	280	520
2	158	693

Beam angle = 120°

MEGAMAN® PLANEX



MEGAMAN® PLANEX



MEGAMAN® PLANEX

Downlight

Ideal for any ceiling with limited depth, MEGAMAN® PLANEX has an ultra slim profile for small cabinets and furniture lighting where space is restricted. Working with LED GX53 lamps, it delivers excellent light output with up to 25,000 hours lifetime without the disadvantages of the extreme heat of halogens such as overheating, discolouration and deformation to furniture and display items.

Features

- Slim design with a recess depth of only 28mm for ultra low profile use
- Perfect for restricted spaces as well as conventional recessed applications
- Adjustable head ($\pm 20^\circ$ tilt angle) for a subtle directional effect
- Can be built in to furniture
- End user serviceable GX53 LED lamp
- Lamp life up to 25,000 hours

Applications

- Restricted depth recessed ceilings
 - Moodlighting in both domestic and hospitality use
 - Furniture lighting
 - Kitchen cabinets
-

MEGAMAN® PLANEX

FDS70618v0

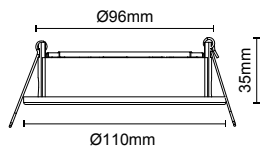

L0504RC

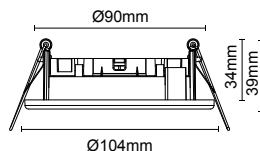
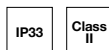

220-240V



Model No.	Max. Wattage (W)	Dimension (mm)	Cut-Out (mm)	Light Source	Lamp Base	Materials
FDS70618v0	7	Ø110 x H35	Ø96	LED GX53	GX53	Polycarbonate
L0504RC	9	Ø104 x H39	Ø90	LED GX53	GX53	Polycarbonate

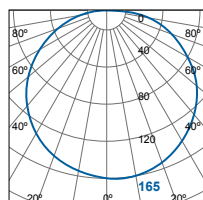
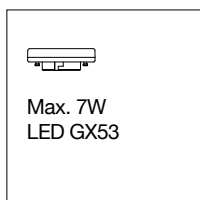

MEGAMAN® PLANEX



MEGAMAN® MILENALITE



MEGAMAN® MILENALITE



MEGAMAN® MILENALITE

Integrated LED Downlight

MEGAMAN® MILENALITE is a cost-effective sustainable downlight solution designed to replace traditional CFL downlights. Featuring LED technology for high luminous efficacy, it allows further energy-saving and uniform light distribution. MEGAMAN® MILENALITE does not require external driver facilitate easy installation and maintenance. The compact design is suitable for limited ceiling depths.

Features

- A range of recessed integrated LED downlights with different optics, including diffuser, reflector and lens version
- No external driver required which facilitates easy installation and maintenance
- Delivers uniform light distribution
- Range of sizes allowing retrofit for many conventional downlights in existing ceiling cut-outs
- Slim design suitable for limited ceiling depths



Applications

- Retails
- Bathrooms
- Hotels
- Kitchens
- Offices
- Restaurants

MEGAMAN® MILENALITE

FDS72600v0

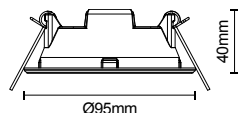
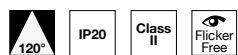

FDS72700v0

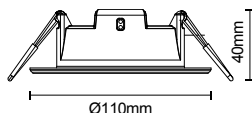
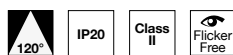

FDM71500v0

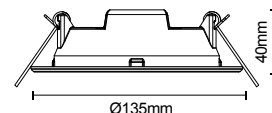
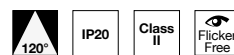

220-240V

White (WH12)

Diffuser

Model No.	Wattage (W)	Luminous Flux (lm)	Luminous Efficacy (lm/W)	Beam Angle (°)	Dimension (mm)	Cut-Out (mm)	Colour Temp. [CRI]	Rated life at L70 B50 at Ta25°C (hrs)	Materials
FDS72600v0	5	370 [3000K] 400 [4000K/6500K]	74 [3000K] 80 [4000K/6500K]	120	Ø95 x H40	Ø75	3000K/4000K/6500K [≥Ra80]	25000	Polycarbonate
FDS72700v0	7	520 [3000K] 560 [4000K/6500K]	74 [3000K] 80 [4000K/6500K]	120	Ø110 x H40	Ø90	3000K/4000K/6500K [≥Ra80]	25000	Polycarbonate
FDM71500v0	9	670 [3000K] 720 [4000K/6500K]	74 [3000K] 80 [4000K/6500K]	120	Ø135 x H40	Ø110	3000K/4000K/6500K [≥Ra80]	25000	Polycarbonate

FDS72600v0

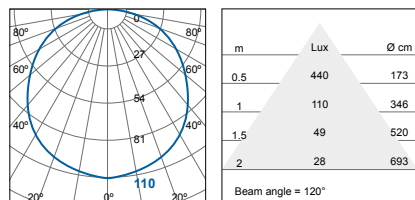

FDS72700v0

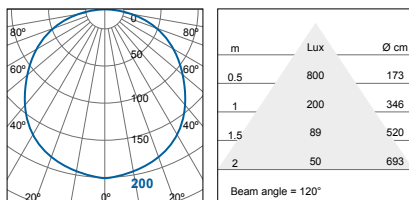

FDM71500v0

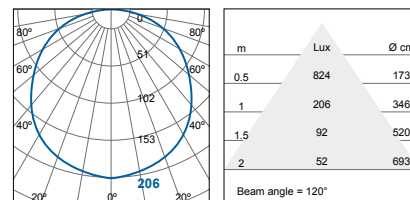

MEGAMAN® MILENALITE

FDL73400v0

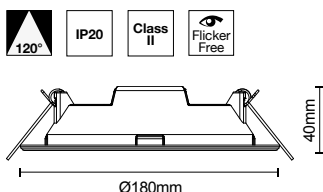

FDL73500v0

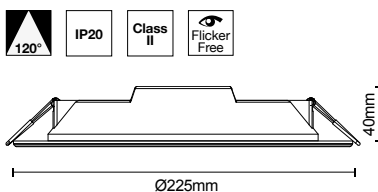

220-240V

White (WH12)

Diffuser

Model No.	Wattage (W)	Luminous Flux (lm)	Luminous Efficacy (lm/W)	Beam Angle (°)	Dimension (mm)	Cut-Out (mm)	Colour Temp. [CRI]	Rated life at L70 B50 at Ta25°C (hrs)	Materials
FDL73400v0	15	1200 [3000K] 1300 [4000K/6500K]	80 [3000K] 87 [4000K/6500K]	120	Ø180 x H40	Ø150	3000K/4000K/6500K [≥Ra80]	25000	Polycarbonate
FDL73500v0	22	1670 [3000K] 1800 [4000K/6500K]	76 [3000K] 82 [4000K/6500K]	120	Ø225 x H40	Ø200	3000K/4000K/6500K [≥Ra80]	25000	Polycarbonate

FDL73400v0

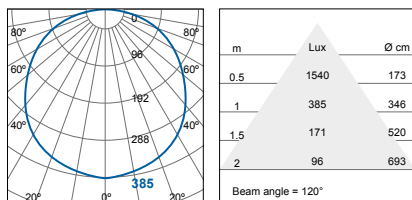

FDL73500v0

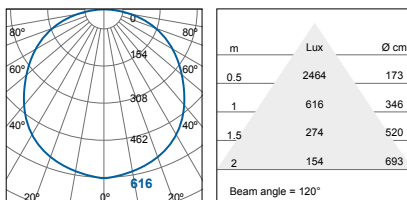

MEGAMAN® MILENALITE

FDS72800v0
FDS72800v1

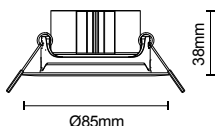

220-240V

White (WH12)

Reflector

Model No.	Wattage (W)	Luminous Flux (lm)	Luminous Efficacy (lm/W)	Beam Angle (°)	Dimension (mm)	Cut-Out (mm)	Colour Temp. [CRI]	Rated life at L70 B50 at Ta25°C (hrs)	Materials
FDS72800v0	5	300 [3000K] 330 [4000K/6500K]	60 [3000K] 66 [4000K/6500K]	36	Ø85 x H38	Ø70	3000K/4000K/6500K [≥Ra80]	25000	PBT
FDS72800v1	7	430 [3000K] 460 [4000K/6500K]	61 [3000K] 66 [4000K/6500K]	36	Ø85 x H38	Ø70	3000K/4000K/6500K [≥Ra80]	25000	PBT

FDS72800v0

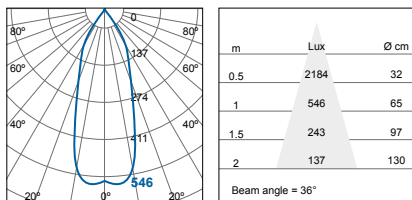

FDS72800v1

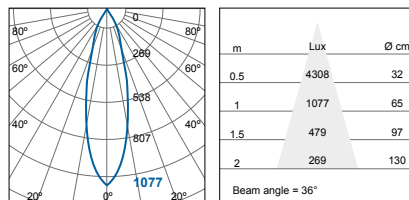

MEGAMAN® MILENALITE

FDS72900v0
FDS72900v1

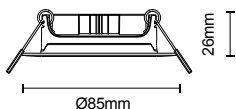

220-240V

White (WH12)

Lens

Model No.	Wattage (W)	Luminous Flux (lm)	Luminous Efficacy (lm/W)	Beam Angle (°)	Dimension (mm)	Cut-Out (mm)	Colour Temp. [CRI]	Rated life at L70 B50 at Ta25°C (hrs)	Materials
FDS72900v0	5	400 [3000K] 430 [4000K/6500K]	80 [3000K] 86 [4000K/6500K]	36	Ø85 x H26	Ø70	3000K/4000K/6500K [≥Ra80]	25000	PBT
FDS72900v1	7	560 [3000K] 600 [4000K/6500K]	80 [3000K] 86 [4000K/6500K]	36	Ø85 x H26	Ø70	3000K/4000K/6500K [≥Ra80]	25000	PBT

FDS72900v0

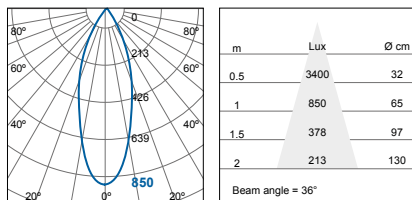

FDS72900v1

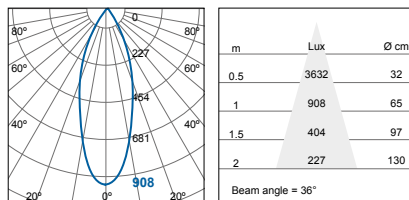

Indoor Lighting / Integrated LED Downlight

MEGAMAN® KAYLA

NEW



MEGAMAN® KAYLA



MEGAMAN® KAYLA

Scenes setting LED downlight

MEGAMAN® KAYLA is LED downlight with scenes setting function via wall switch, suitable for interior designing to enhance the atmosphere and beauty of lighting for residential and commercial application.

Features

- Scenes setting with memory function
- 3 scenes setting via on/off switch
- Integrated design easy installation
- Loop through function available
- Compatible with different wires from 0.75mm², 1.0mm² and 1.5mm²
- Easy installation thanks for the build in cable clamp

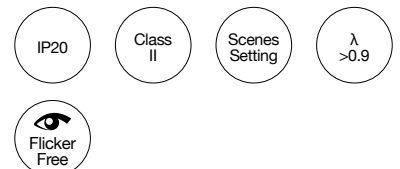

Applications

- Hotels
- Corridors
- Bedroom
- Residential application

MEGAMAN® KAYLA

FDS72200v0-ss

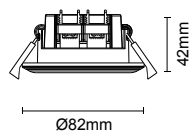
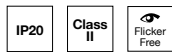

FDM71100v0-ss

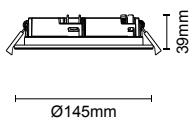
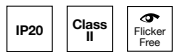

220-240V

White (WH26)

Model No.	Wattage (W)	Luminous Flux (lm)	Colour Temp. [CRI]	Dimension (mm)	Cut-out (mm)	Rated Life at L70 B50 at Ta25°C (hrs)	Scenes Setting
FDS72200v0-ss	4	350	2700K / 4000K	Ø82 x 42	Ø65	25000	3 Scenes
FDM71100v0-ss	8.4	800	2700K / 4000K	Ø145 x 39	Ø130	25000	3 Scenes



MEGAMAN® KAYLA

FDS72500v0-ss



IP20 Class II Flicker Free

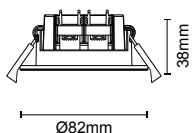

FDM71200v0-ss



IP20 Class II Flicker Free

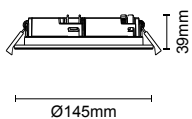

220-240V

White (WH126)

Model No.	Wattage (W)	Luminous Flux (lm)	Colour Temp. [CRI]	Dimension (mm)	Cut-out (mm)	Rated Life at L70 B50 at Ta25°C (hrs)	Scenes Setting
FDS72500v0-ss	4	350	2700K / 4000K	Ø82 x 38	Ø65	25000	3 Scenes
FDM71200v0-ss	8.4	800	2700K / 4000K	Ø145 x 39	Ø130	25000	3 Scenes



MEGAMAN® GEO 3



NEW



Indoor Lighting / High Bay
MEGAMAN® GEO 3



MEGAMAN® GEO 3

High Bay

MEGAMAN® GEO 3 with a smart looking design in durable die-cast aluminium housing with anti-corrosion coating. Modular plug and play microwave motion sensor with standby dimming which configuring by optional remote controller for energy saving and safety consideration. Four selectable lumen output enhance the flexibility of application.

Features

- Replacement for traditional high bay in durable die-cast aluminium with anti-corrosion powder coating
- High luminous efficacy with up to 180lm/W
- Easy installation with single point hook mounting design
- IP65 protection and high vandal resistant with IK08 50,000hrs@L80B50 @Ta40°C ; 70,000hrs@L70B50 @Ta25°C
- Modular plug and play microwave motion sensor, with standby dimming (configuring by optional remote controller).
- Equipped with 50cm length H05RN-F 3*1.0mm² power cable with IP65 connector
- High surge protection level: 4000V (L-N) ; 6000V (L,N-PE)
- Operation temperature -30°C to +50°C



Applications

- High-ceiling areas
- Halls
- Warehouses
- General manufacturing

MEGAMAN® GEO 3

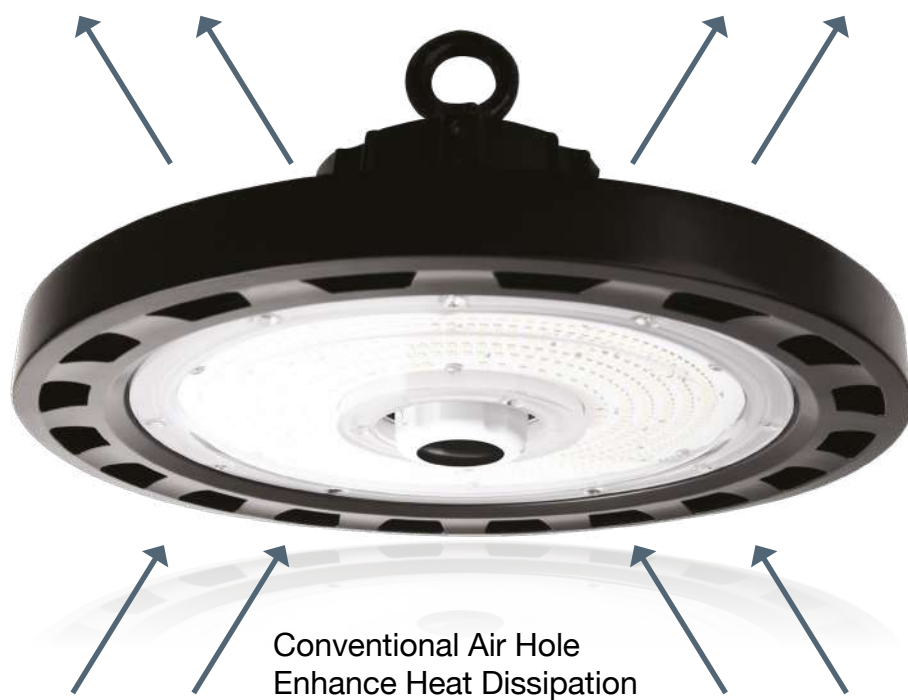

Microwave Sensor Module / Stand-By Dim Level



Selectable Lumen Output

150W	27000 lm	200W	36000 lm
120W	21600 lm	180W	32400 lm
100W	18000 lm	150W	27000 lm
70W	12600 lm	120W	21600 lm

DALI 2.0 version available soon

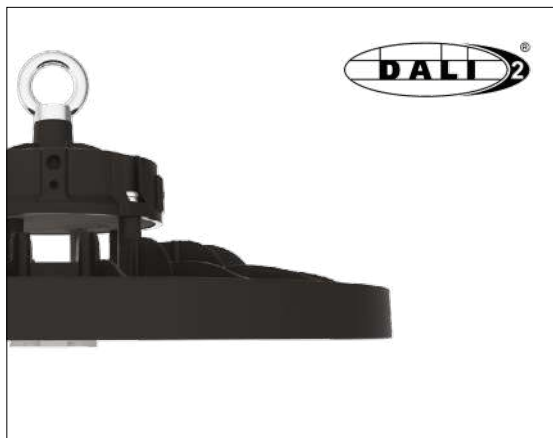

Emergency Kit for GEO 3

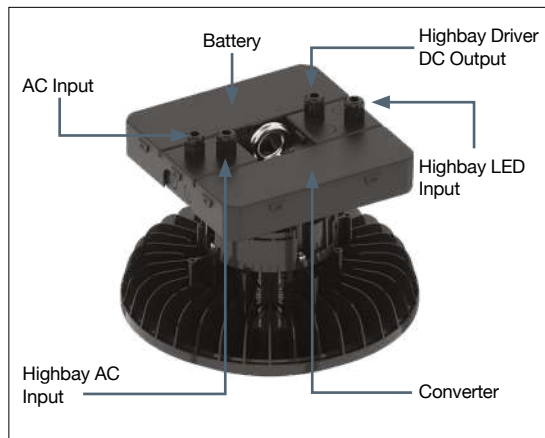

Indoor Lighting / High Bay
MEGAMAN® GEO 3

FHB72300v0-ds/dc

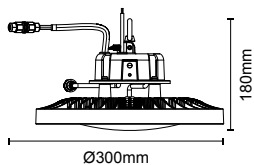

FHB72400v0-ds/dc

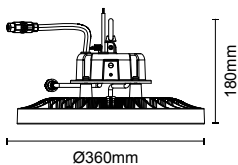

FHB72300v0-da

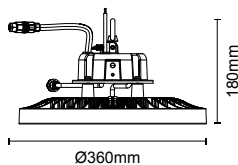

FHB72400v0-da

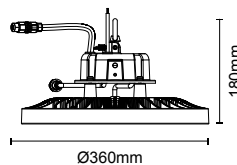

220-240V

Black (BK12)

Model No.	Wattage (W)	Luminous Flux (lm)	Luminous Efficacy (lm/W)	Dimension (mm)	Colour Temp. [CRI]	Rated Life at L70B50 at Ta40°C (hrs)	Dimmable	Power Factor (λ)	Materials
FHB72300v0-ds/dc	150/120/100/70	27000/21600/18000/12600	180	Ø300 x H180	4000K [Ra80]	50000	0-10V ON/OFF	> 0.9	Graphene Housing, PC diffuser
FHB72400v0-ds/dc	200/180/150/120	36000/32400/27000/21600	180	Ø360 x H180	4000K [Ra80]	50000	0-10V ON/OFF	> 0.9	Graphene Housing, PC diffuser
FHB72300v0-da	150	27000	180	Ø300 x H180	4000K [Ra80]	50000	DALI 2.0	> 0.9	Graphene Housing, PC diffuser
FHB72400v0-da	200	36000	180	Ø360 x H180	4000K [Ra80]	50000	DALI 2.0	> 0.9	Graphene Housing, PC diffuser

Accessory



LA11225
Emergency Kit 5W 3H



LA11233
Sensor



LA11234
Remote Control

MEGAMAN® GEO 3

FHB71000v0-dc/ds+060D (150W)
FHB71000v0-da+060D (150W)

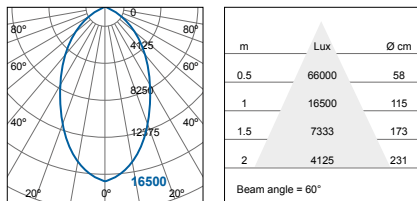

FHB71000v0-dc/ds+060D (125W)
FHB71000v0-da+060D (125W)

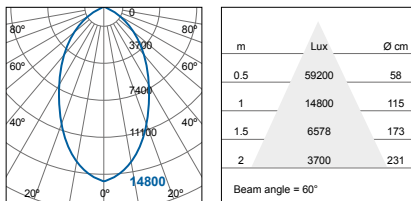

FHB71000v0-dc/ds+060D (100W)
FHB71000v0-da+060D (1100W)

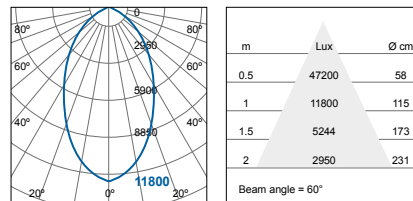

FHB71000v0-dc/ds+060D (90W)
FHB71000v0-da+060D (90W)

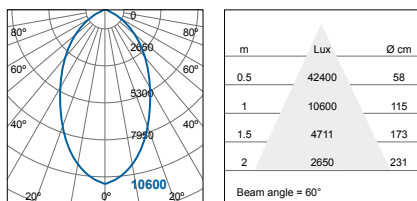

FHB71000v0-dc/ds+060D (70W)
FHB71000v0-da+060D (70W)

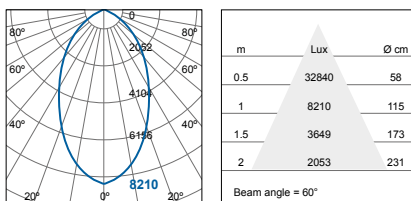

FHB71000v0-dc/ds+110D (150W)
FHB71000v0-da+110D (150W)

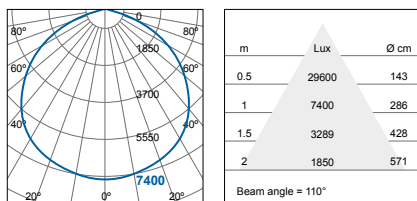

FHB71000v0-dc/ds+110D (125W)
FHB71000v0-da+110D (125W)

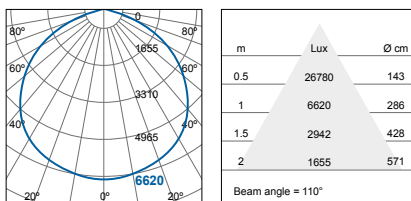

FHB71000v0-dc/ds+110D (100W)
FHB71000v0-da+110D (100W)

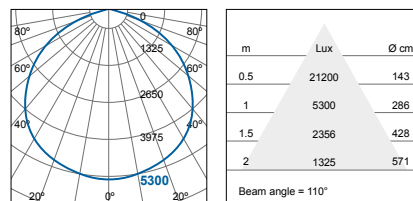

FHB71000v0-dc/ds+110D (90W)
FHB71000v0-da+110D (90W)

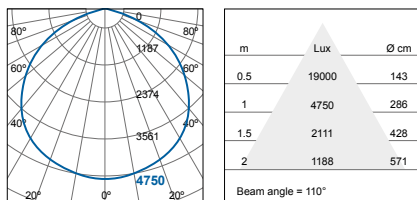

FHB71000v0-dc/ds+110D (70W)
FHB71000v0-da+110D (70W)

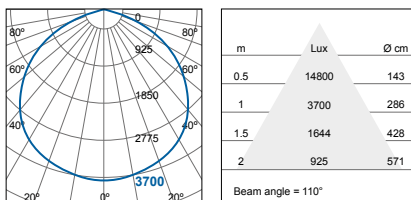

FHB71000v1-dc/ds+110D (165W)
FHB71000v1-da+110D (165W)

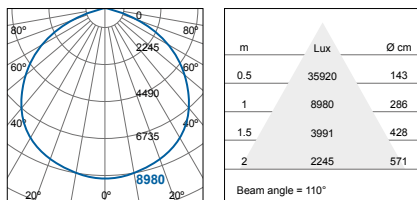

FHB71000v1-dc/ds+110D (125W)
FHB71000v1-da+110D (125W)

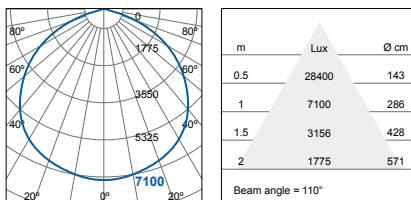

FHB71000v1-dc/ds+110D (115W)
FHB71000v1-da+110D (115W)

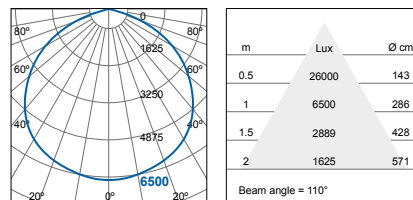

FHB71000v1-dc/ds+110D (90W)
FHB71000v1-da+110D (90W)

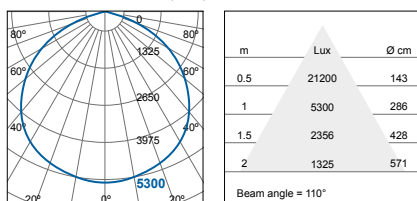

FHB71000v1-dc/ds+110D (80W)
FHB71000v1-da+110D (80W)

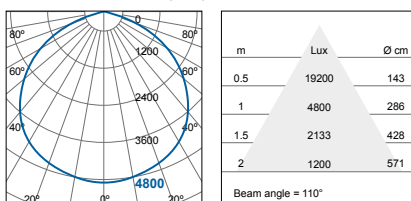

Indoor Lighting / High Bay

MEGAMAN® GEO 3

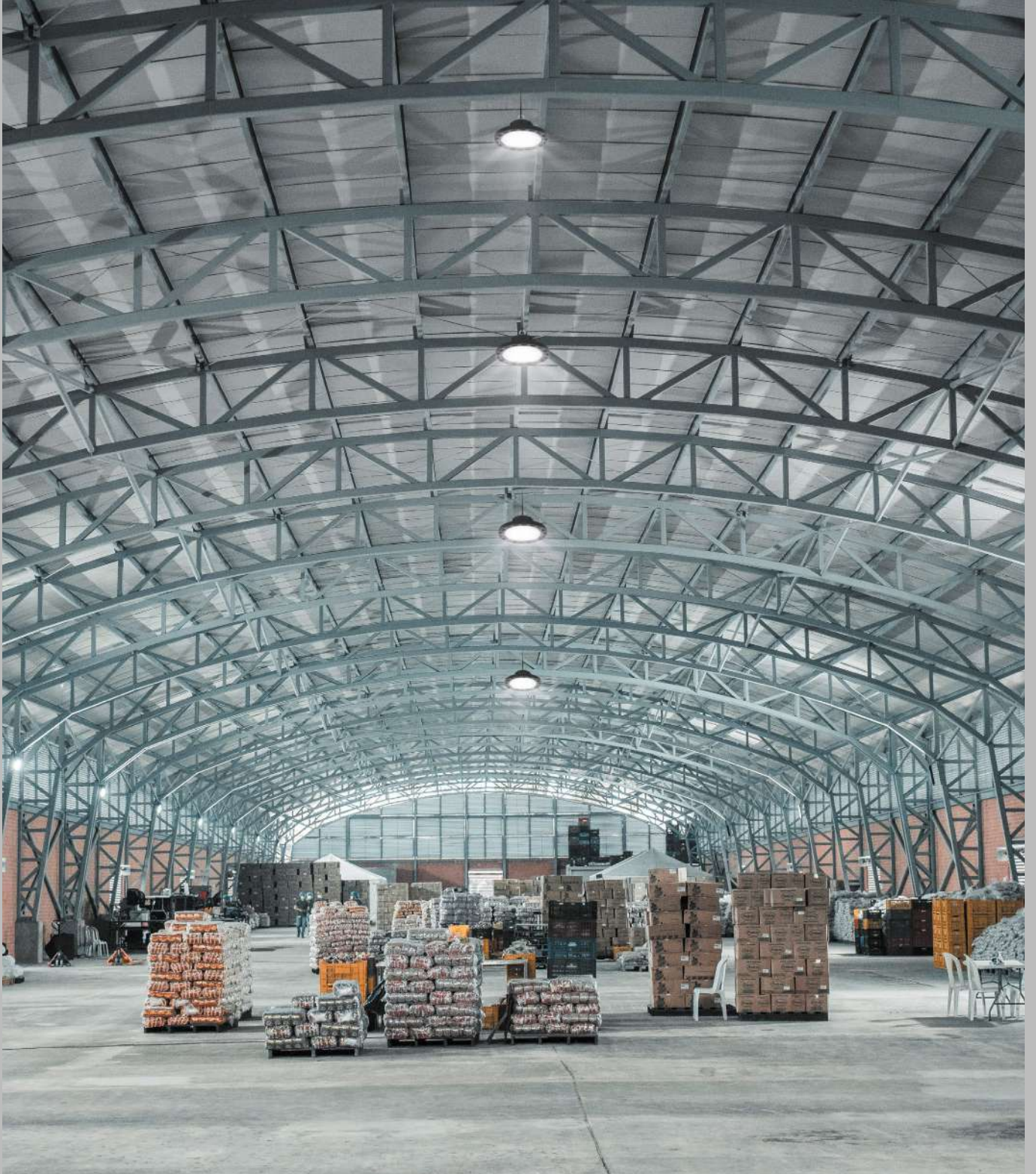

MEGAMAN® KEO 2

NEW



Indoor Lighting / High Bay
MEGAMAN® KEO 2



MEGAMAN® KEO 2
 High Bay

MEGAMAN® KEO 2 is a cost-effective high bay with a smart looking design in durable die-cast aluminum housing with anti-corrosion coating. Modular plug and play microwave motion sensor which configuring by optional remote controller for energy saving. Selectable lumen output enhance the flexibility of application.

Features

- Replacement for traditional high bay in durable die-cast aluminum with anti-corrosion powder coating
- High luminous efficacy with up to 165lm/W
- Easy installation with single point hook mounting design
- IP65 protection and high vandal resistant with IK08
- Long life time span 50,000hrs@L80B50 @Ta40°C
- Modular plug and play microwave motion sensor (configuring by optional remote controller).
- Equipped with 30cm length H05RN-F 3*1.0mm² power cable with IP65 connector
- High surge protection level: 6kV (L-N) ; 6kV (L,N-PE)
- Operation temperature -30°C to +50°C



Microwave Motion Sensor

IP65

IK09

50000 hrs



110°

$\lambda > 0.9$

Applications

- High-ceiling areas
- Halls
- Warehouses
- General manufacturing

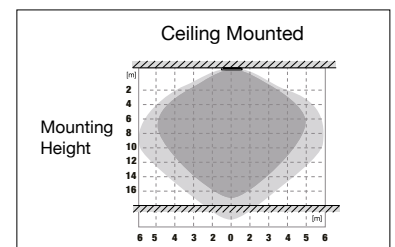

MEGAMAN® KEO 2 microwave sensor detects movement within around 5-6m radius horizontally and / or 10-12m vertically beneath sensor, and only lights up when movement detected for energy saving.

MEGAMAN® KEO 2

FHB72500v0-ds

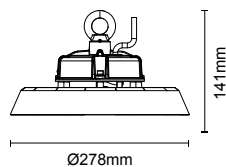

FHB72600v0-ds

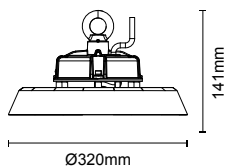

FHB72700v0-ds

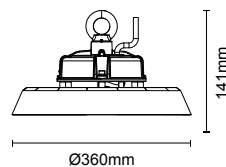
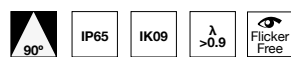

220-240V

Black (BK13)

Model No.	Wattage (W)	Luminous Flux (lm)	Luminous Efficacy (lm/W)	Colour Temp. [CRI]	Beam Angle(°)	Power Factor (λ)	Rated Life at L70B50 at Ta40°C (hrs)	Dimension (mm)	Material
FHB72500v0-ds	100/80/60	15500/12800/9900	155/160/165	4000K [Ra80]	90	0.9	50000	Ø278 x H141	Aluminium Diecast housing + Polycarbonate diffuser
FHB72600v0-ds	150/120/80	23250/19200/1320	155/160/165	4000K [Ra80]	90	0.9	50000	Ø320 x H141	Aluminium Diecast housing + Polycarbonate diffuser
FHB72700v0-ds	200/150/100	31000/24000/1650	155/160/165	4000K [Ra80]	90	0.9	50000	Ø360 x H141	Aluminium Diecast housing + Polycarbonate diffuser

Accessory



LA11201
Microwave Motion Sensor



LA11207
Motion Sensor Remote - Pro



LA11202
Motion Sensor Remote - Standard



LA11238
100W Alum Reflector Standard



LA11239
150W Alum Reflector Standard



LA11240
200W Alum Reflector Standard



LA11241
100W PC Reflector



LA11242
150W PC Reflector



LA11243
200W PC Reflector



LA11237
Universal Rotatable Bracket



LA11236
Safety Chain

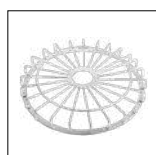

LA11244
100W Safe Guard

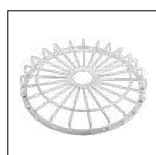

LA11245
150W Safe Guard

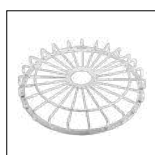

LA11246
200W Safe Guard

MEGAMAN® KEO 2

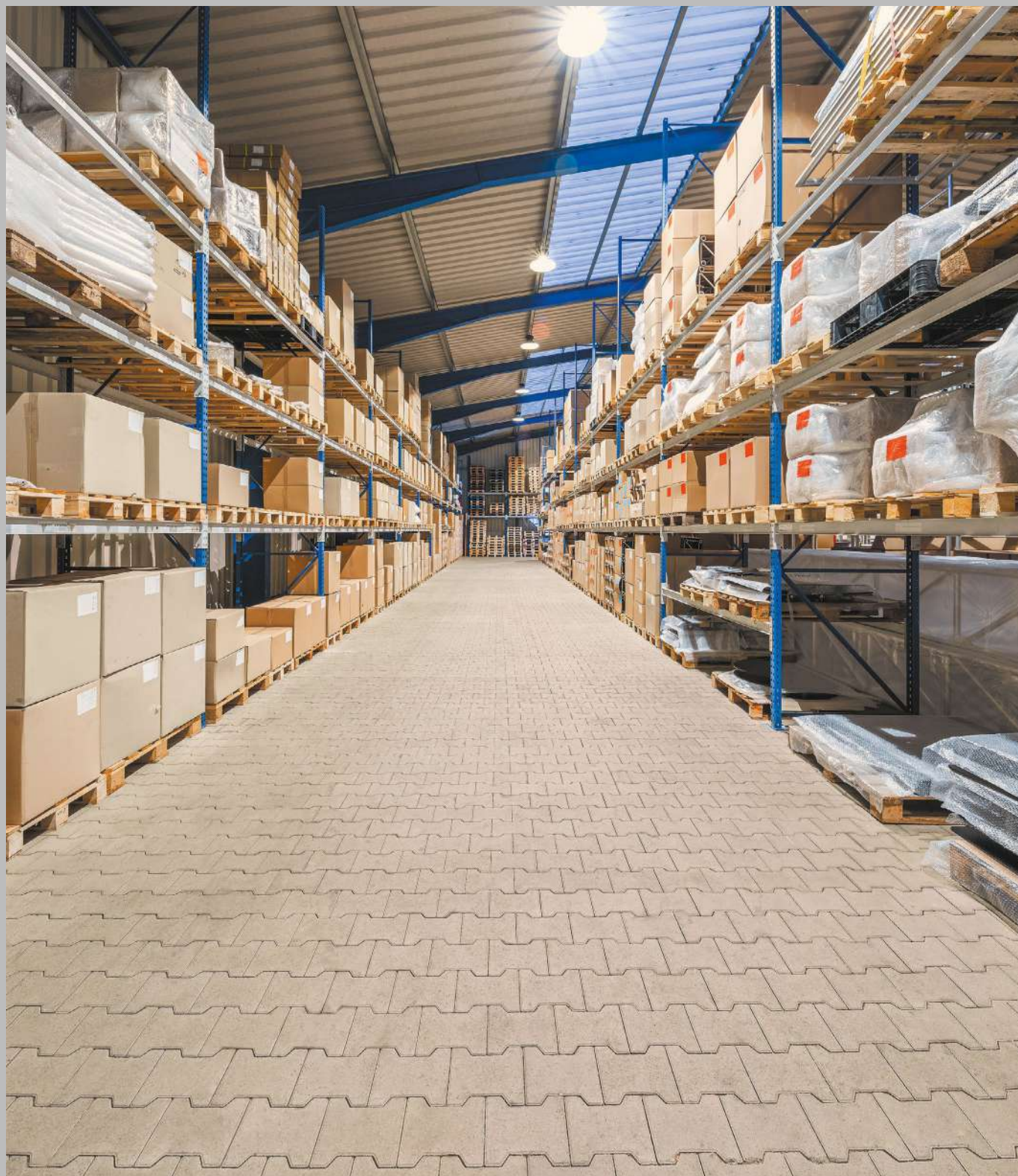

MEGAMAN® TONO 2



MEGAMAN® TONO 2



MEGAMAN® TONO 2

Integrated LED Batten

MEGAMAN® TONO 2 is a cost-effective and reliable indoor LED batten minimizing the initial investment without compromising flexibility. The luminaire is not only saving much energy costs compared to traditional battens, but also offering a longer lifetime. This results in significantly lower operational costs, ensuring a payback that meets the needs of the specification market.

Features

- MEGAMAN® TONO 2 is an integrated LED batten, as an ideal alternative to T5 and T8 fluorescent fittings
- UK BESA connection box compatible
- Compliant with the building regulation, approved document B “Fire Safety” – Classification TP(b)
- Available in 5 different sizes, i.e.: 600mm, 900mm, 1200mm, 1500mm and 1800mm
- Enhancing efficacy up to 117lm/W
- Long life time (50,000hrs@L70B50 at Ta25°C)
- Flicker free

Up to
117
lm/W

50000
hrs

Flicker
free

Applications

- Residential lighting
- Under cabinet
- Staircases
- Corridors
- Factories
- Warehouse



UK BESA box compatible

MEGAMAN® TONO 2

FIB70500v2



$\lambda > 0.9$ Class II Flicker Free

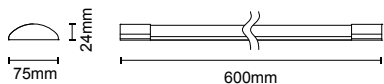

FIB73300v0



$\lambda > 0.9$ Class II Flicker Free

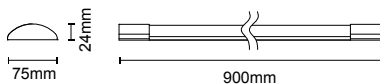

FIB70600v2



$\lambda > 0.9$ Class II Flicker Free

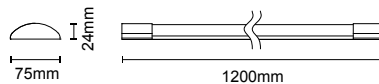

220-240V IP20

White (WH12)

Model No.	Wattage (W)	Luminous Flux (lm)	Luminous Efficacy (lm/W)	Beam Angle (°)	Dimension (mm)	Colour Temp. [CRI]	Rated Life at L70 B50 at Ta25°C (hrs)	Material
FIB70500v2	20	2050 [3000K]	103 [3000K]	110	L600 x W75 x H24	3000K [≥80]	50000	Polycarbonate
FIB70500v2	20	2200 [4000K]	110 [4000K]	110	L600 x W75 x H24	4000K [≥80]	50000	Polycarbonate
FIB73300v0	29	3050 [3000K]	105 [3000K]	110	L900 x W75 x H24	3000K [≥80]	50000	Polycarbonate
FIB73300v0	29	3300 [4000K]	114 [4000K]	110	L900 x W75 x H24	4000K [≥80]	50000	Polycarbonate
FIB70600v2	38	4050 [3000K]	107 [3000K]	110	L1200 x W75 x H24	3000K [≥80]	50000	Polycarbonate
FIB70600v2	38	4350 [4000K]	114 [4000K]	110	L1200 x W75 x H24	4000K [≥80]	50000	Polycarbonate

FIB70500v2

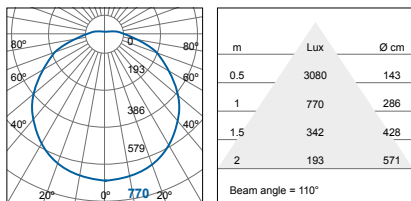

FIB73300v0

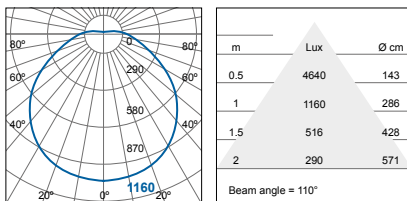

FIB70600v2

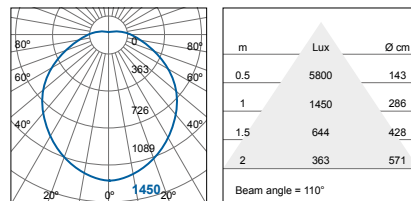

MEGAMAN® TONO 2

FIB70700v2



$\lambda > 0.9$ Class II Flicker Free

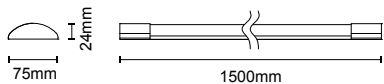

FIB73400v0



$\lambda > 0.9$ Class II Flicker Free

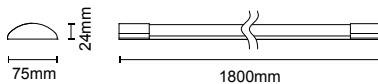

220-240V IP20

White (WH12)

Model No.	Wattage (W)	Luminous Flux (lm)	Luminous Efficacy (lm/W)	Beam Angle (°)	Dimension (mm)	Colour Temp. [CRI]	Rated Life at L70 B50 at Ta25°C (hrs)	Material
FIB70700v2	48	5200 [3000K]	108 [3000K]	110	L1500 x W75 x H24	3000K [≥80]	50000	Polycarbonate
FIB70700v2	48	5600 [4000K]	117 [4000K]	110	L1500 x W75 x H24	4000K [≥80]	50000	Polycarbonate
FIB70700v2	48	5600 [6500K]	117 [6500K]	110	L1500 x W75 x H24	6500K [≥80]	50000	Polycarbonate
FIB73400v0	56	6100 [3000K]	109 [3000K]	110	L1800 x W75 x H24	3000K [≥80]	50000	Polycarbonate
FIB73400v0	56	6550 [4000K]	117 [4000K]	110	L1800 x W75 x H24	4000K [≥80]	50000	Polycarbonate
FIB73400v0	56	6550 [6500K]	117 [6500K]	110	L1800 x W75 x H24	6500K [≥80]	50000	Polycarbonate

FIB70700v2

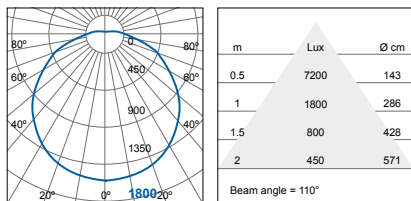

FIB73400v0

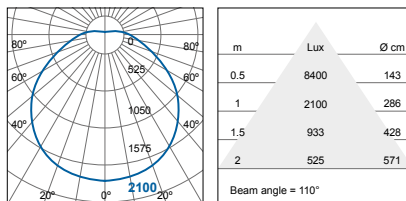

MEGAMAN® FARRON



Standard Version



Emergency Version

MEGAMAN® FARRON

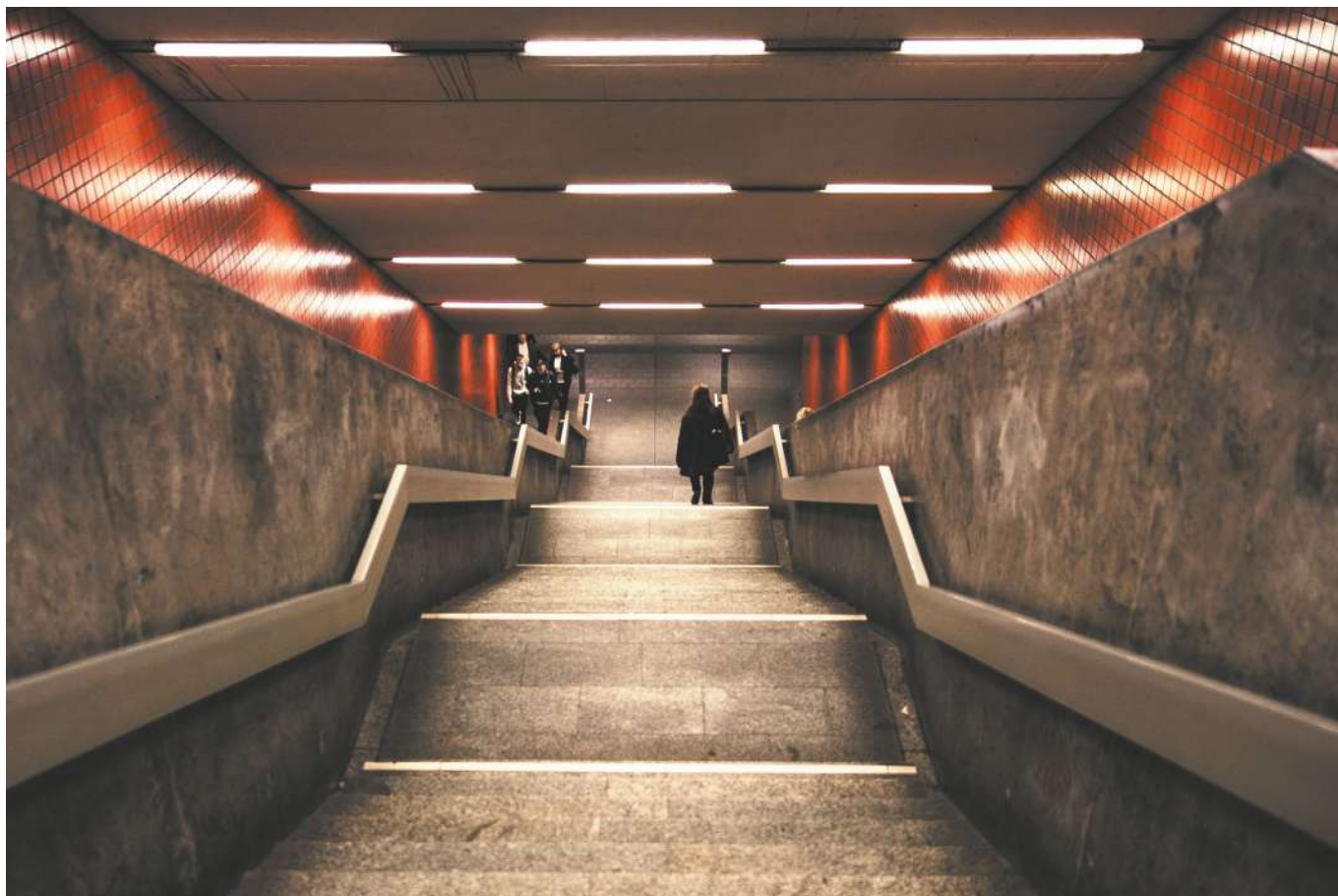

MEGAMAN® FARRON

Integrated LED Batten

MEGAMAN® FARRON is a basic solution for general lighting that provide quality of light, substantial energy and maintenance saving. It is an ideal replacement for conventional indoor batten with optional features of built in microwave sensor and 3 hour emergency kit to provide functional flexibility with a consistent outlook.

Features

- Direct 1 to 1 replacement of conventional indoor batten in LED solution
- Slim and versatile outlook
- 2-step lumen output in one fitting
- 0-10V dimming available
- Built in Microwave sensor & emergency kit provide a consistent outlook with standard version
- White powder coating
- Capable to connect with conduit at both end by Ø25mm knockout
- Click in opal diffuser into metal mounting base
- Easy and tool-less installation & wiring
- Selectable lumen, Sensor & Emergency kit options available
- Capable to mount in UK Beza box



Applications

- Residential lighting
- Schools
- Public area
- Factories
- Corridors
- Warehouse

Accessory

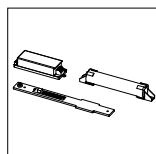

LA11161
Emergency module

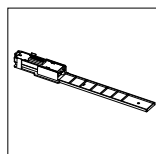

LA11162
Microwave Motion
Sensor

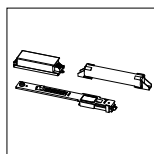

LA11163
Microwave Motion Sensor
Emergency module

MEGAMAN® FARRON

FIB73500v0-ds
FIB73600v0-ds
FIB73700v0-ds
FIB73800v0-ds

FIB73500v0-ds/ms
FIB73600v0-ds/ms
FIB73700v0-ds/ms
FIB73800v0-ds/ms

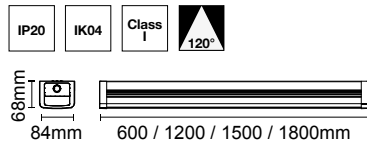

220-240V $\lambda > 0.9$

White (WH12)

Model No.	Wattage (W)	Luminous Flux (lm)	Luminous Efficacy (lm/W)	Dimension (mm)	Colour Temp. [CRI]	Rated Life at L80 B10 at Ta25°C	Materials
Standard Version							
FIB73500v0-ds	10/21	930/1950 [3000K] 1000/2100 [4000K/6500K]	93 [3000K] 100 [4000K/6500K]	L600 x W84 x H68	3000K/4000K/6500K [>Ra80]	50000	Steel housing + Polycarbonate diffuser
FIB73600v0-ds	20/40	1850/3700 [3000K] 2000/4000 [4000K/6500K]	93 [3000K] 100 [4000K/6500K]	L1200 x W84 x H68	3000K/4000K/6500K [>Ra80]	50000	Steel housing + Polycarbonate diffuser
FIB73700v0-ds	22/52	2400/4800 [3000K] 2600/5200 [4000K/6500K]	109/92 [3000K] 118/100 [4000K/6500K]	L1500 x W84 x H68	3000K/4000K/6500K [>Ra80]	50000	Steel housing + Polycarbonate diffuser
FIB73800v0-ds	26/52	3100/5900 [3000K] 3400/6400 [4000K/6500K]	119/113 [3000K] 131/123 [4000K/6500K]	L1800 x W84 x H68	3000K/4000K/6500K [>Ra80]	50000	Steel housing + Polycarbonate diffuser
With Microwave Sensor							
FIB73500v0-ds/ms	10/21	930/1950 [3000K] 1000/2100 [4000K/6500K]	93 [3000K] 100 [4000K/6500K]	L600 x W84 x H68	3000K/4000K/6500K [>Ra80]	50000	Steel housing + Polycarbonate diffuser
FIB73600v0-ds/ms	20/40	1850/3700 [3000K] 2000/4000 [4000K/6500K]	93 [3000K] 100 [4000K/6500K]	L1200 x W84 x H68	3000K/4000K/6500K [>Ra80]	50000	Steel housing + Polycarbonate diffuser
FIB73700v0-ds/ms	22/52	2400/4800 [3000K] 2600/5200 [4000K/6500K]	109/92 [3000K] 118/100 [4000K/6500K]	L1500 x W84 x H68	3000K/4000K/6500K [>Ra80]	50000	Steel housing + Polycarbonate diffuser
FIB73800v0-ds/ms	26/52	3100/5900 [3000K] 3400/6400 [4000K/6500K]	119/113 [3000K] 131/123 [4000K/6500K]	L1800 x W84 x H68	3000K/4000K/6500K [>Ra80]	50000	Steel housing + Polycarbonate diffuser

FIB73500v0-ds
FIB73500v0-ds/ms

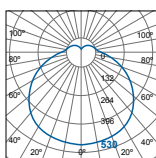

m	Lux	Ø cm
0.5	2120	173
1	530	346
1.5	236	520
2	133	693

Beam angle = 120°

FIB73600v0-ds
FIB73600v0-ds/ms

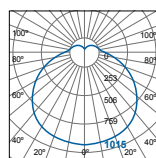

m	Lux	Ø cm
0.5	4060	173
1	1015	346
1.5	451	520
2	254	693

Beam angle = 120°

FIB73700v0-ds
FIB73700v0-ds/ms

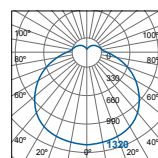

m	Lux	Ø cm
0.5	5280	173
1	1320	346
1.5	587	520
2	330	693

Beam angle = 120°

FIB73800v0-ds
FIB73800v0-ds/ms

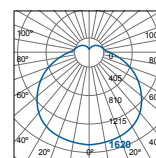

m	Lux	Ø cm
0.5	6480	173
1	1620	346
1.5	720	520
2	405	693

Beam angle = 120°

* Operation temperature from -30°C to +45°C; White models emergency modular is 0°C to +35°C

MEGAMAN® FARRON

FIB73500v0-ds/em
FIB73600v0-ds/em
FIB73700v0-ds/em
FIB73800v0-ds/em

FIB73500v0-ds/em/ms
FIB73600v0-ds/em/ms
FIB73700v0-ds/em/ms
FIB73800v0-ds/em/ms

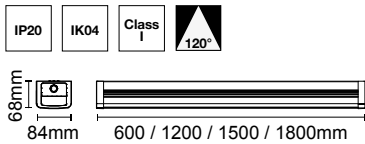
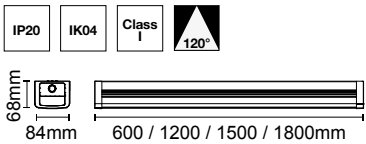

220-240V $\lambda > 0.9$

White (WH12)

Model No.	Wattage (W)	Luminous Flux (lm)	Luminous Efficacy (lm/W)	Dimension (mm)	Colour Temp. [CRI]	Rated Life at L80 B10 at Ta25°C	Materials
With Emergency							
FIB73500v0-ds/em	14/25	930/1950 [3000K] 1000/2100 [4000K/6500K]	66/78 [3000K] 71/84 [4000K/6500K]	L600 x W84 x H68	3000K/4000K/6500K [>Ra80]	50000	Steel housing + Polycarbonate diffuser
FIB73600v0-ds/em	24/44	1850/3700 [3000K] 2000/4000 [4000K/6500K]	77/84 [3000K] 83/91 [4000K/6500K]	L1200 x W84 x H68	3000K/4000K/6500K [>Ra80]	50000	Steel housing + Polycarbonate diffuser
FIB73700v0-ds/em	26/56	2400/4800 [3000K] 2600/5200 [4000K/6500K]	92/86 [3000K] 100/93 [4000K/6500K]	L1500 x W84 x H68	3000K/4000K/6500K [>Ra80]	50000	Steel housing + Polycarbonate diffuser
FIB73800v0-ds/em	30/56	3100/5900 [3000K] 3400/6400 [4000K/6500K]	103/105 [3000K] 113/114 [4000K/6500K]	L1800 x W84 x H68	3000K/4000K/6500K [>Ra80]	50000	Steel housing + Polycarbonate diffuser
With Microwave Sensor							
FIB73500v0-ds/em/ms	14/25	930/1950 [3000K] 1000/2100 [4000K/6500K]	66/78 [3000K] 71/84 [4000K/6500K]	L600 x W84 x H68	3000K/4000K/6500K [>Ra80]	50000	Steel housing + Polycarbonate diffuser
FIB73600v0-ds/em/ms	24/44	1850/3700 [3000K] 2000/4000 [4000K/6500K]	77/84 [3000K] 83/91 [4000K/6500K]	L1200 x W84 x H68	3000K/4000K/6500K [>Ra80]	50000	Steel housing + Polycarbonate diffuser
FIB73700v0-ds/em/ms	26/56	2400/4800 [3000K] 2600/5200 [4000K/6500K]	92/86 [3000K] 100/93 [4000K/6500K]	L1500 x W84 x H68	3000K/4000K/6500K [>Ra80]	50000	Steel housing + Polycarbonate diffuser
FIB73800v0-ds/em/ms	30/56	3100/5900 [3000K] 3400/6400 [4000K/6500K]	103/105 [3000K] 113/114 [4000K/6500K]	L1800 x W84 x H68	3000K/4000K/6500K [>Ra80]	50000	Steel housing + Polycarbonate diffuser

FIB73500v0-ds/em
FIB73500v0-ds/em/ms

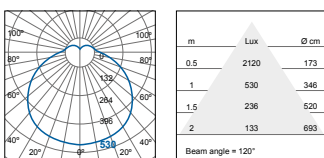

FIB73600v0-ds/em
FIB73600v0-ds/em/ms

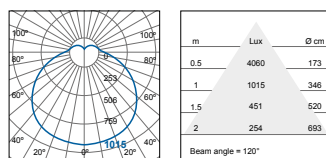

FIB73700v0-ds/em
FIB73700v0-ds/em/ms

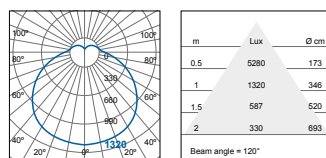

FIB73800v0-ds/em
FIB73800v0-ds/em/ms

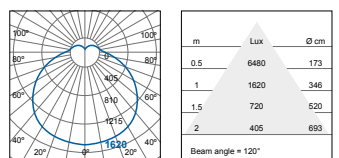

* Operation temperature from -30°C to +45°C; White models emergency modular is 0°C to +35°C

MEGAMAN® GABIO 2



NEW

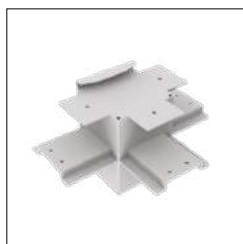

Indoor Lighting / LED Linear Profile
MEGAMAN® GABIO 2

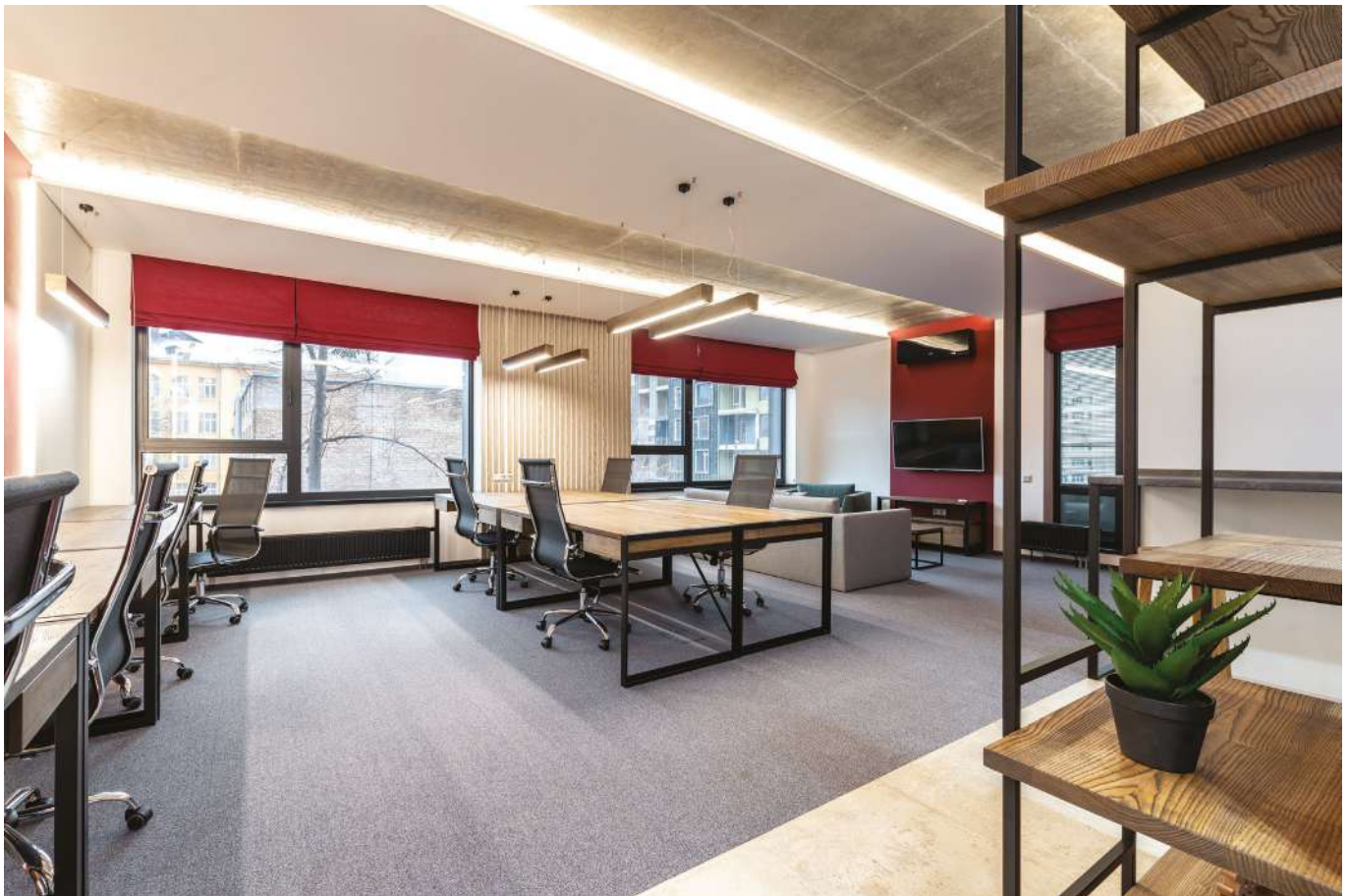

MEGAMAN® GABIO 2

LED Linear Profile

New generation of slim aluminium linear profile fixtures MEGAMAN® GABIO 2 with louvre design and also diffuser version to fit any interior. MEGAMAN® GABIO 2 with low glare rating for high visual comfort and deliver high uniformity of lighting. Different mounting X, L, T connectors with integrated LED louvre cells for continuous line of light or different connections.

Features

- New generation of slim aluminum linear profile fixtures with understated design fits any interior
- Louvre cell design with low glare rating for high visual comfort, ideal for individual task lighting
- Wide batwing light distribution and wide beam angle deliver high uniformity
- Different mounting methods to cater for different applications: surface-mount, suspension and recessed (with additional accessory kit)
- Modular system for linear series connection available by different joints Innovative X, L, T connectors with integrated LED louvre cells for continuous line of light, making junctions invisible
- Slim slot in surface mount/suspension mounting clips

Accessory

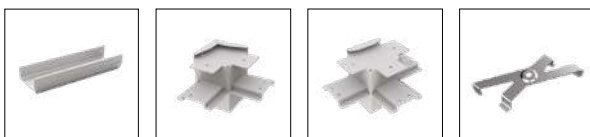

LA6044
Connector kit

LA6050
L Connector

LA6051
T Connector

LA6052
X Connector



Applications

- Offices
- Schools
- Department stores
- Commercial applications

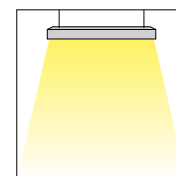

Direct lighting

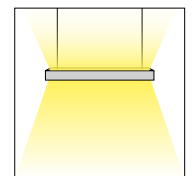

Direct-indirect lighting

MEGAMAN® GABIO 2

FLP70400v0-ds/sc
FLP70400v0-da/sc



UGR ≤19 IP20 Class I λ >0.9

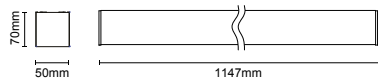

FLP70500v0-ds/sc
FLP70500v0-da/sc



UGR ≤19 IP20 Class I λ >0.9

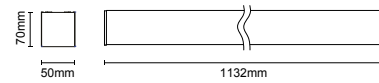

220-240V

Silver (SV61)

Direct Light Distribution

ON/OFF Version

Model No.	Wattage (W)	Luminous Flux (lm)	Luminous Efficacy (lm/W)	Beam Angle (°)	Dimension (mm)	Colour Temp. [CRI]	Rated Life at L70 B50 at Ta25°C (hrs)	Dimmable	Power Factor (λ)	Material
FLP70400v0-ds/sc	29/16	3200/1750 3500/1900	110 [3000K] 120 [4000K]	65	L 1147x W50 x H70	3000K / 4000K [≥Ra80]	50000	N/A	>0.9	Aluminium
FLP70500v0-ds/sc	35/18	3850/2000 4200/2150	110 [3000K] 120 [4000K]	65	L 1132x W50 x H70	3000K / 4000K [≥Ra80]	50000	N/A	>0.9	Aluminium

DALI Version

FLP70400v0-da/sc	29	3200/3500	110 [3000K] 120 [4000K]	65	L 1147x W50 x H70	3000K / 4000K [≥Ra80]	50000	N/A	>0.9	Aluminium
FLP70500v0-da/sc	35	3850/4200	110 [3000K] 120 [4000K]	65	L 1132x W50 x H70	3000K / 4000K [≥Ra80]	50000	N/A	>0.9	Aluminium

FLP70400v0-ds/sc (29W)

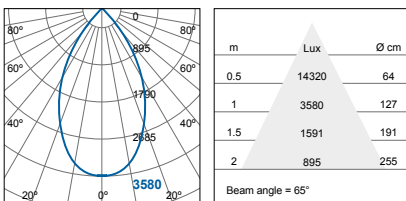

FLP70400v0-ds/sc (16W)

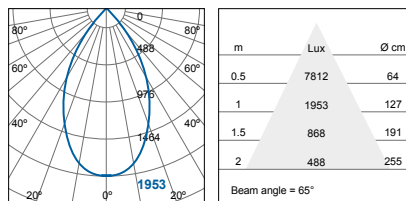

FLP70500v0-ds/sc (35W)

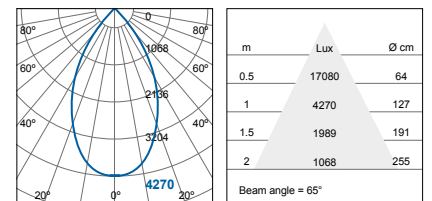

FLP70500v0-ds/sc (18W)

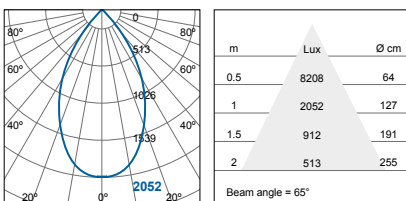

FLP70400v0-da/sc (29W)

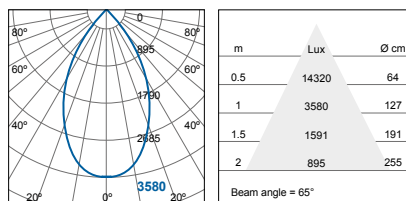

FLP70500v0-da/sc (35W)

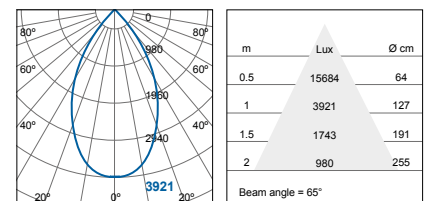

MEGAMAN® GABIO 2



Indoor Lighting / Damp Proof Batten

MEGAMAN® NARDOS 2



NEW



Indoor Lighting / Damp Proof Batten

MEGAMAN® NARDOS 2



MEGAMAN® NARDOS 2

Integrated Damp Proof Batten

MEGAMAN® NARDOS 2 is a cost-effective and reliable LED batten minimizing the initial investment without compromising flexibility. It is available in three lengths and two versions (loop through and non-loop through). MEGAMAN® NARDOS 2 is an ideal luminaire range for applications such as car parks and warehouses, while delivering a significant lighting performance.

Features

- Designed with a tough polycarbonate body with IK08 rating for vandal resistance
- Flicker free
- High power factor >0.9
- Cable entries and through wiring allow for linear series connection



Applications

- Car parks
- Garages
- Under canopy
- Subways
- Workshops
- Warehouses and similar applications

Toolless wiring and easy installation

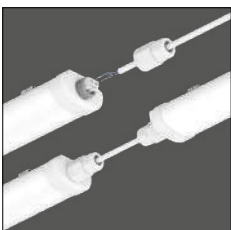

Easy installation mounting clips

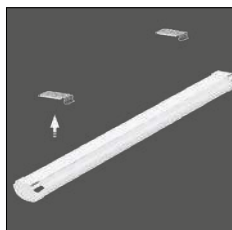

MEGAMAN® NARDOS 2

FOB81200v0



IP65 λ >0.9 Class II

FOB81300v0



IP65 λ >0.9 Class II

FOB81400v0



IP65 λ >0.9 Class II

220-240V

Grey (SV16)

Loop Through Version

Model No.	Wattage (W)	Luminous Flux (lm)	Lm/W	Colour Temp.	CRI	Dimension (mm)	Rated Life at L70B50 at Ta25°C (hrs)	Materials
FOB81200v0	20	2000	100	4000K	≥80	W72 x H42 x L635	35000	Polycarbonate
FOB81300v0	40	4000	100	4000K	≥80	W72 x H42 x L1235	35000	Polycarbonate
FOB81400v0	50	5000	100	4000K	≥80	W72 x H42 x L1535	35000	Polycarbonate

Indoor Lighting / Damp Proof Batten
MEGAMAN® NARDOS 2

FOB83200v0



IP65 λ >0.9 Class II

FOB83300v0



IP65 λ >0.9 Class II

FOB83400v0



220-240V

Grey (SV16)

Non-Loop Through Version

Model No.	Wattage (W)	Luminous Flux (lm)	Lm/W	Colour Temp.	CRI	Dimension (mm)	Rated Life at L70B50 at Ta25°C (hrs)	Materials
FOB83200v0	20	2000	100	4000K	≥80	W72 x H42 x L635	35000	Polycarbonate
FOB83300v0	40	4000	100	4000K	≥80	W72 x H42 x L1235	35000	Polycarbonate
FOB83400v0	50	5000	100	4000K	≥80	W72 x H42 x L1535	35000	Polycarbonate

MEGAMAN® GARRON



MEGAMAN® GARRON



MEGAMAN® GARRON

Integrated LED Batten

MEGAMAN® GARRON is an ideal replacement for conventional indoor batten with optional features of built in microwave sensor and 3 hours emergency kit to provide functional flexibility as a solution for general lighting that provide quality of light.

Features

- Replacement for conventional indoor batten
- Built in Microwave sensor and emergency kit provide a consistent outlook with standard version
- 4 different length 600mm, 1200mm, 1500mm and 1800mm
- Easy installation and Tool-less wiring
- Sensor and Emergency options available
- Capable to mount in UK Beza box



Applications

- Residential lighting
- Schools
- Factories
- Corridors
- Warehouses

MEGAMAN® GARRON

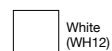
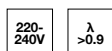
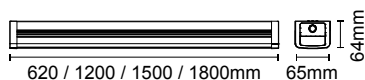

Single Tube Replacement

Model No.	Wattage (W)	Luminous Flux (lm)	Efficiency (lm/W)	Colour Temp. (CRI)	Beam Angle (°)	Dimension (mm)	Rated Life @L70B50 @ Ta25°C (hrs)	Materials
Standard Version								
FIB76200v0	10	1200	120	4000K [≥80]	110	L620 x W64 x H65	30000	Metal housing + PC diffuser
FIB76300v0	20	2400	120	4000K [≥80]	110	L1200 x W64 x H65	30000	Metal housing + PC diffuser
FIB76400v0	30	3600	120	4000K [≥80]	110	L1500 x W64 x H65	30000	Metal housing + PC diffuser
FIB76500v0	40	4800	120	4000K [≥80]	110	L1800 x W64 x H65	30000	Metal housing + PC diffuser
With Microwave Sensor								
FIB76200v0-ms	11	1200	109	4000K [≥80]	110	L620 x W64 x H65	30000	Metal housing + PC diffuser
FIB76300v0-ms	21	2400	114	4000K [≥80]	110	L1200 x W64 x H65	30000	Metal housing + PC diffuser
FIB76400v0-ms	31	3600	116	4000K [≥80]	110	L1500 x W64 x H65	30000	Metal housing + PC diffuser
FIB76500v0-ms	41	4800	117	4000K [≥80]	110	L1800 x W64 x H65	30000	Metal housing + PC diffuser
With Emergency								
FIB76200v0-em	11	1200	109	4000K [≥80]	110	L620 x W64 x H65	30000	Metal housing + PC diffuser
FIB76300v0-em	21	2400	114	4000K [≥80]	110	L1200 x W64 x H65	30000	Metal housing + PC diffuser
FIB76400v0-em	31	3600	116	4000K [≥80]	110	L1500 x W64 x H65	30000	Metal housing + PC diffuser
FIB76500v0-em	41	4800	117	4000K [≥80]	110	L1800 x W64 x H65	30000	Metal housing + PC diffuser
With Microwave Sensor and Emergency								
FIB76200v0-em/ms	12	1200	100	4000K [≥80]	110	L620 x W64 x H65	30000	Metal housing + PC diffuser
FIB76300v0-em/ms	22	2400	109	4000K [≥80]	110	L1200 x W64 x H65	30000	Metal housing + PC diffuser
FIB76400v0-em/ms	32	3600	113	4000K [≥80]	110	L1500 x W64 x H65	30000	Metal housing + PC diffuser
FIB76500v0-em/ms	42	4800	114	4000K [≥80]	110	L1800 x W64 x H65	30000	Metal housing + PC diffuser



FIB76200v0-ms
FIB76300v0-ms
FIB76400v0-ms
FIB76500v0-ms



FIB76200v0-em/ms
FIB76300v0-em/ms
FIB76400v0-em/ms
FIB76500v0-em/ms





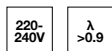
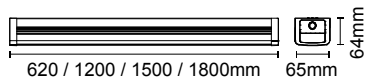

FIB76200v0-em
FIB76300v0-em
FIB76400v0-em
FIB76500v0-em

MEGAMAN® GARRON



Double Tube Replacement

Model No.	Wattage (W)	Luminous Flux (lm)	Efficiency (lm/W)	Colour Temp. (CRI)	Beam Angle (°)	Dimension (mm)	Rated Life @L70B50 @ Ta25°C (hrs)	Materials
Standard Version								
FIB76200v1	17	2040	120	4000K [≥80]	110	L620 x W64 x H65	30000	Metal housing + PC diffuser
FIB76300v1	40	4800	120	4000K [≥80]	110	L1200 x W64 x H65	30000	Metal housing + PC diffuser
FIB76400v1	60	7200	120	4000K [≥80]	110	L1500 x W64 x H65	30000	Metal housing + PC diffuser
FIB76500v1	65	7800	120	4000K [≥80]	110	L1800 x W64 x H65	30000	Metal housing + PC diffuser
With Microwave Sensor 								
FIB76200v1-ms	18	2040	113	4000K [≥80]	110	L620 x W64 x H65	30000	Metal housing + PC diffuser
FIB76300v1-ms	41	4800	117	4000K [≥80]	110	L1200 x W64 x H65	30000	Metal housing + PC diffuser
FIB76400v1-ms	61	7200	118	4000K [≥80]	110	L1500 x W64 x H65	30000	Metal housing + PC diffuser
FIB76500v1-ms	66	7800	118	4000K [≥80]	110	L1800 x W64 x H65	30000	Metal housing + PC diffuser
With Emergency 								
FIB76200v1-em	18	2040	113	4000K [≥80]	110	L620 x W64 x H65	30000	Metal housing + PC diffuser
FIB76300v1-em	41	4800	117	4000K [≥80]	110	L1200 x W64 x H65	30000	Metal housing + PC diffuser
FIB76400v1-em	61	7200	118	4000K [≥80]	110	L1500 x W64 x H65	30000	Metal housing + PC diffuser
FIB76500v1-em	66	7800	118	4000K [≥80]	110	L1800 x W64 x H65	30000	Metal housing + PC diffuser
With Microwave Sensor and Emergency  								
FIB76200v1-em/ms	19	2040	107	4000K [≥80]	110	L620 x W64 x H65	30000	Metal housing + PC diffuser
FIB76300v1-em/ms	42	4800	114	4000K [≥80]	110	L1200 x W64 x H65	30000	Metal housing + PC diffuser
FIB76400v1-em/ms	62	7200	116	4000K [≥80]	110	L1500 x W64 x H65	30000	Metal housing + PC diffuser
FIB76500v1-em/ms	67	7800	116	4000K [≥80]	110	L1800 x W64 x H65	30000	Metal housing + PC diffuser

MEGAMAN® PINOLITE 2

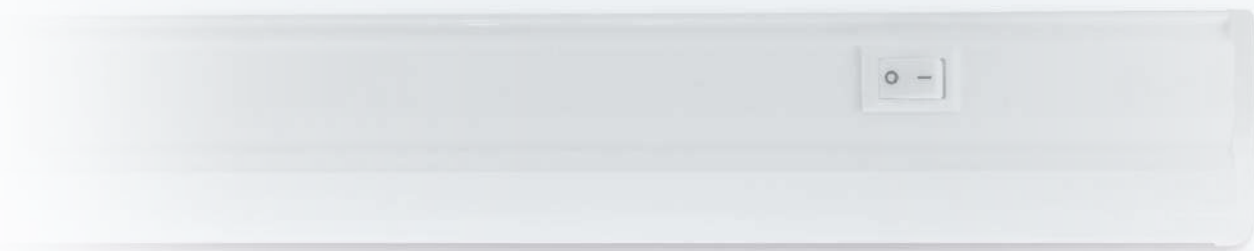

MEGAMAN® PINOLITE 2



MEGAMAN® PINOLITE 2

Integrated LED Batten

MEGAMAN® PINOLITE 2 is the right choice for recessed wall wash, display shelf lighting and concealed linear lighting applications. The integrated LED linear tube design with high system luminous efficacy of up to 134lm/W is a true replacement for traditional T5 battens.

Features

- Energy saving LED linear batten to replace conventional T5 Batten
- Tool-less installation. Plug-and-play connection
- Long life, low maintenance cost
- Durable and economical solution
- Offers various lengths for flexible solutions: 0.3m, 0.6m, 0.9m, 1.2m and 1.5m
- Integrated connector makes allows easy in line connection for continuous runs
- Translucent end caps reduce dark zones
- Built in ON/OFF switch
- Accessories included: patch cord, mounting clips, power cord and continuous connector
- Optional accessories: adjustable mounting clips can be adjustable 90° with adjustable mounting clips



Translucent end-cap design that eliminates the dark zone between the batten connections



Extension connector



15cm patch cord to cater angular connection



Applications

- Shops and boutiques
- Display shelves
- Wall lighting
- Light troughs
- Offices

Default accessories:



Extension connector x 1, raw plug x 1 and mounting kit (mounting clips x 2, screws x 2, expansion screws x 2)

Optional accessories:



LA8126
Adjustable mounting clip



LA8132
15cm Patch cord

LA8130
1.8m EU plug Power cord

LA8131
1.8m UK plug Power cord

MEGAMAN® PINOLITE 2

FIB75500v0

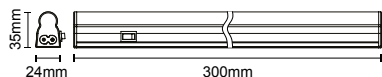
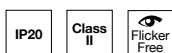

FIB75600v0

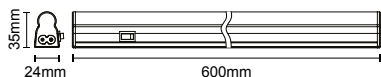
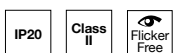

FIB75700v0

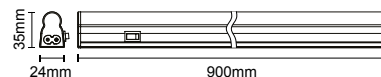
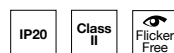

220-240V

White (WH13)

Model No.	Wattage (W)	Luminous Flux (lm)	Luminous Efficacy (lm/W)	Beam Angle (°)	Dimension (mm)	Colour Temp. [CRI]	Power Factor (λ)	Rated Life at L70 B50 at Ta25°C (hrs)	Material
FIB75500v0	5	550 [3000K] 600 [4000K / 6500K]	110 [3000K] 120 [4000K / 6500K]	150	L300 x W24 x H35	3000K / 4000K / 6500K	>0.9	30000	Polycarbonate housing + Polycarbonate diffuser
FIB75600v0	9	1000 [3000K] 1100 [4000K / 6500K]	111 [3000K] 122 [4000K / 6500K]	150	L600 x W24 x H35	3000K / 4000K / 6500K	>0.9	30000	Polycarbonate housing + Polycarbonate diffuser
FIB75700v0	13	1500 [3000K] 1650 [4000K / 6500K]	115 [3000K] 127 [4000K / 6500K]	150	L900 x W24 x H35	3000K / 4000K / 6500K	>0.9	30000	Polycarbonate housing + Polycarbonate diffuser

FIB75500v0 (3000K)

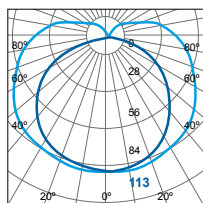

m	Lux	Ø cm
0.5	452	373
1	113	746
1.5	50	1120
2	28	1493

Beam angle = 150°

FIB75600v0 (3000K)

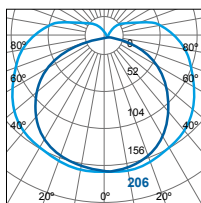

m	Lux	Ø cm
0.5	824	373
1	206	746
1.5	92	1120
2	52	1493

Beam angle = 150°

FIB75700v0 (3000K)

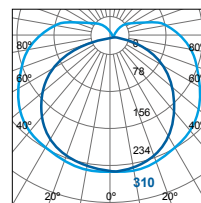

m	Lux	Ø cm
0.5	1240	373
1	310	746
1.5	138	1120
2	78	1493

Beam angle = 150°

FIB75500v0 (4000K / 6500K)

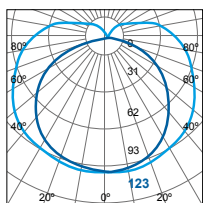

m	Lux	Ø cm
0.5	492	373
1	123	746
1.5	55	1120
2	31	1493

Beam angle = 150°

FIB75600v0 (4000K / 6500K)

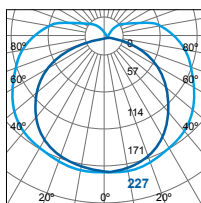

m	Lux	Ø cm
0.5	908	373
1	227	746
1.5	101	1120
2	57	1493

Beam angle = 150°

FIB75700v0 (4000K / 6500K)

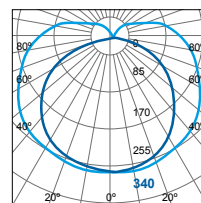

m	Lux	Ø cm
0.5	1360	373
1	340	746
1.5	151	1120
2	85	1493

Beam angle = 150°

MEGAMAN® PINOLITE 2

FIB75800v0



IP20 Class II Flicker Free

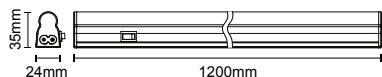

FIB75900v0



IP20 Class II Flicker Free

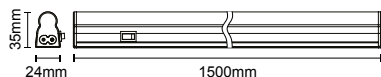

220-240V

White (WH13)

Model No.	Wattage (W)	Luminous Flux (lm)	Luminous Efficacy (lm/W)	Beam Angle (°)	Dimension (mm)	Colour Temp. [CRI]	Power Factor (λ)	Rated Life at L70 B50 at Ta25°C (hrs)	Material
FIB75800v0	16	1900 [3000K] 2150 [4000K / 6500K]	119 [3000K] 134 [4000K / 6500K]	150	L1200 x W24 x H35	3000K / 4000K / 6500K	>0.9	30000	Polycarbonate housing + Polycarbonate diffuser
FIB75900v0	21	2400 [3000K] 2600 [4000K / 6500K]	114 [3000K] 124 [4000K / 6500K]	150	L1500 x W24 x H35	3000K / 4000K / 6500K	>0.9	30000	Polycarbonate housing + Polycarbonate diffuser

FIB75800v0 (3000K)

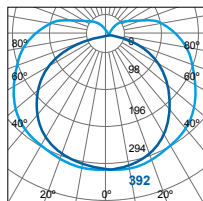

m	Lux	Ø cm
0.5	1568	373
1	392	746
1.5	174	1120
2	98	1493

Beam angle = 150°

FIB75900v0 (3000K)

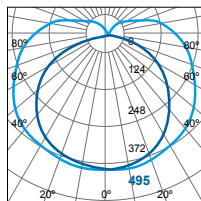

m	Lux	Ø cm
0.5	1980	373
1	495	746
1.5	220	1120
2	124	1493

Beam angle = 150°

FIB75800v0 (4000K / 6500K)

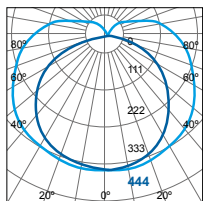

m	Lux	Ø cm
0.5	1776	373
1	444	746
1.5	197	1120
2	111	1493

Beam angle = 150°

FIB75900v0 (4000K / 6500K)

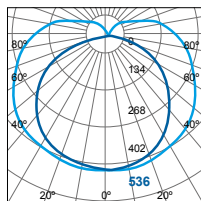

m	Lux	Ø cm
0.5	2144	373
1	536	746
1.5	238	1120
2	134	1493

Beam angle = 150°

MEGAMAN® PINOLITE 2

FIB75500v1-pt

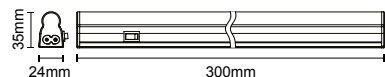
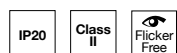

FIB75600v1-pt

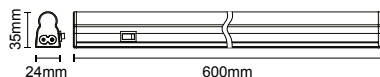
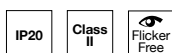

FIB75600v1-pt

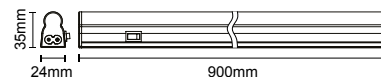
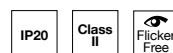

220-240V

White (WH13)

Plant Lamp

Model No.	Wattage (W)	Photon Flux (μmol/s)	Photon Flux / watt (μmol/J)	Beam Angle (°)	Dimension (mm)	Rated Lifetime L70B50@Ta25°C	IP Rating	Material
FIB75500v1-pt	5	10*	2*	150	L300 x W24 x H35	30000	IP20	Polycarbonate housing + Polycarbonate diffuser
FIB75600v1-pt	9	18*	2*	150	L600 x W24 x H35	30000	IP20	Polycarbonate housing + Polycarbonate diffuser
FIB75800v1-pt	16	32*	2*	150	L1200 x W24 x H35	30000	IP20	Polycarbonate housing + Polycarbonate diffuser

* Preliminary data

FIB75500v1-pt

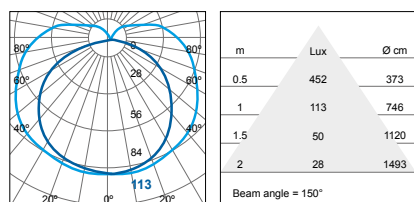

FIB75600v1-pt

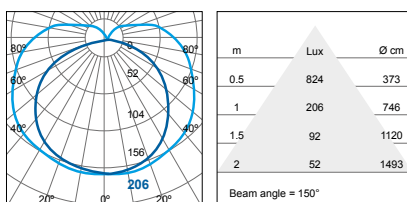

FIB75800v1-pt

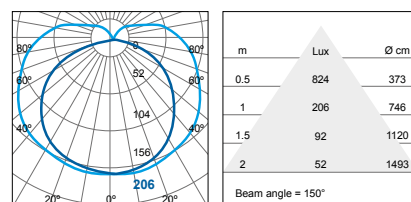

PINOLITE 2 Plant Lamp

- Different lengths (0.3m / 0.6m / 1.2m) of battens available for various horticulture applications
- Energy saving with high efficacy of up to 2.0μmol/J
- Offer the most suitable illumination intensity and photosynthetically active region (PAR) in deep blue 450nm and hyper red 660nm that the crops need for photosynthesis
- Excellent light uniformity to shorten the production cycle by enhancing the seeding rate and survival rate, as a result of achieving a higher return of each crop
- Suitable for tomato, cabbage, baby leaf lettuce, kale plants, lettuce, green onions, etc.

MEGAMAN® PINOLITE 2





MEGAMAN® FORD

Integrated LED Batten

MEGAMAN® FORD is the ideal batten choice for true replacements of traditional T5 and T8 with up to 44% energy saving, providing high quality lighting in designated area.

Features

- Compact design, Integrated driver with built-in LED that facilitates easy installation and servicing
- Loop through connection enhancing the flexibility of installations
- Surface-mounted or wire suspension options available

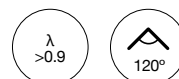

Applications

- Residential lighting
- Factories
- Corridors
- Warehouses

Indoor Lighting / Batten

MEGAMAN® FORD

FIB74100v0 / FIB74200v0
FIB74300v0



λ >0.9 Class II

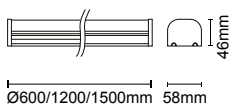

220-240V IP20

Silver (SV16)

Model No.	Wattage (W)	Luminous Flux (lm)	Luminous Efficacy (lm/W)	Beam Angle (°)	Dimension (mm)	Colour Temp. [CRI]	Rated Life at L70 B50 at Ta25°C (hrs)	Material
FIB74100v0	30	2400	80	120	L600 x W58 x H46	3000K / 4000K / 6500K	25000	Polycarbonate
FIB74200v0	45	3600	80	120	L1200 x W58 x H46	3000K / 4000K / 6500K	25000	Polycarbonate
FIB74300v0	60	4800	80	120	L1500 x W58 x H46	3000K / 4000K / 6500K	25000	Polycarbonate

FIB74100v0 (3000K)

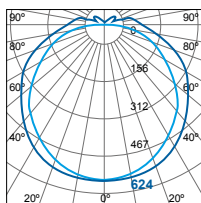

m	Lux	Ø cm
0.5	2496	173
1	624	346
1.5	277	520
2	156	693

Beam angle = 120°

FIB74200v0 (3000K)

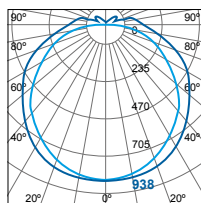

m	Lux	Ø cm
0.5	3752	173
1	938	346
1.5	417	520
2	235	693

Beam angle = 120°

FIB74300v0 (3000K)

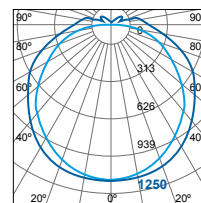

m	Lux	Ø cm
0.5	5000	173
1	1250	346
1.5	556	520
2	313	693

Beam angle = 120°

FIB74100v0 (4000K, 6500K)

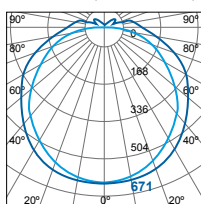

m	Lux	Ø cm
0.5	2684	173
1	671	346
1.5	298	520
2	168	693

Beam angle = 120°

FIB74200v0 (4000K, 6500K)

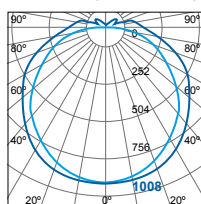

m	Lux	Ø cm
0.5	4032	173
1	1008	346
1.5	448	520
2	252	693

Beam angle = 120°

FIB74300v0 (4000K, 6500K)

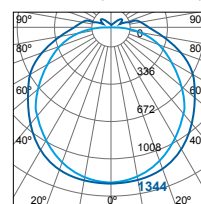

m	Lux	Ø cm
0.5	5376	173
1	1344	346
1.5	597	520
2	336	693

Beam angle = 120°

Indoor Lighting / Integrated Waterproof Batten

MEGAMAN® MILO



MEGAMAN® MILO



MEGAMAN® MILO

Integrated Waterproof Batten

MEGAMAN® MILO is a cost-effective and reliable LED batten minimizing the initial investment. It comes with sliding stainless steel clips for easy and tool-less installation. MEGAMAN® MILO is an ideal luminaire for applications such as car parks and warehouses, while delivering a significant lighting performance.

Features

- Light in weight and compact slim profile of batten delivers easy and quick installation
- Designed for both indoor or moisture environments
- IP65 protection against water ingress
- High impact resistant of IK08
- Diffused and uniformed light
- Sliding stainless steel clips make surface mounted installation simple, quick and neat
- Withstand in high working temperature up to 50°C with operating temperature from -30°C to +50°C
- Low flickering $\leq 8\%$

Tool-less wiring

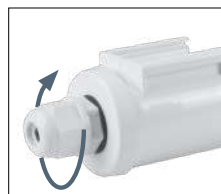

Applications

- Household garage
- Car parks
- Workshops
- Underground areas

MEGAMAN® MILO

FOB77300v0

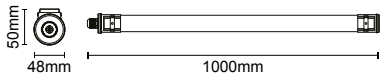
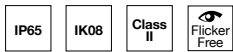

220-240V

White (WH26)

Model No.	Wattage (W)	Luminous Flux (lm)	Lm/W	Beam Angle (°)	Dimension (mm)	Colour Temp. [CRI]	Rated Life at L70B50 at Ta25°C (hrs)	Materials
FOB77300v0	21	1800	86	120	L1030 x W48 x H56	4000K (≥80)	15000	Polycarbonate

FOB77300v0

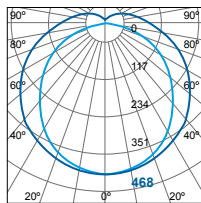

m	Lux	Ø cm
0.5	1872	173
1	468	346
1.5	208	520
2	117	693

Beam angle = 120°

MEGAMAN® MILO

FOB77300v1-pt
 FOB77300v1-pt+LA8142

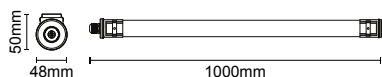
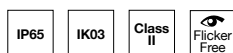

220-240V

White (WH26)

Plant Lamp

Model No.	Wattage (W)	Photon Flux (μmol/s)	Photon Flux / watt (μmol/J)	Beam Angle (°)	Dimension (mm)	Rated Lifetime L70B50@Ta25°C	Material
FOB77300v1-pt	19	36	2.0	120	L1000 x W48 x H50	25,000	Polycarbonate
FOB77300v1-pt +LA8142	19	36	2.0	120	L1000 x W48 x H50	25,000	Polycarbonate

FOB77300v1-pt
 FOB77300v1-pt +LA8142

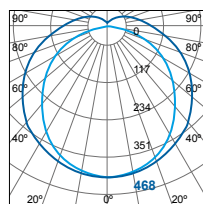

m	Lux	Ø cm
0.5	1872	173
1	468	346
1.5	208	520
2	117	693

Beam angle = 120°



MILO Plant Lamp

- MILO Plant lamp version available for various horticulture applications
- Energy saving with high efficacy of up to 2.0μmol/J
- Offer the most suitable illumination intensity and photosynthetically active region (PAR) in deep blue 450nm and hyper red 660nm that the crops need for photosynthesis
- Excellent light uniformity to shorten the production cycle by enhancing the seeding rate and survival rate, as a result of achieving a higher return of each crop
- Suitable for tomato, cabbage, baby leaf lettuce, kale plants, lettuce, green onions, etc.

Accessories:

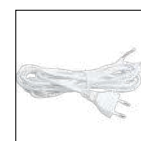

LA8142
 1.8M cable with EU plug

MEGAMAN® BERTO SIDELIT

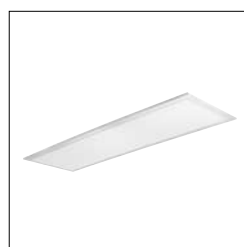

MEGAMAN® BERTO SIDELIT



MEGAMAN® BERTO SIDELIT

LED Panel

MEGAMAN® BERTO is an ultra slim integrated lighting solution that facilitates easy installation and maintenance. It delivers luminous efficacy at 100lm/W – matching the lighting levels of 3 x 18W T8 and 3 x 24W HE T5 fluorescent modular fittings.

These luminaires have a long life and provide uniform light distribution for general lighting applications. The prismatic diffuser option with Unified Glare Rating (UGR) of ≤ 19 offers a high level of visual comfort and avoids fatigue to the eyes, ideal for use in offices, classrooms and corridors.

Features

- Slim integrated panel lighting design facilitates easy installation and maintenance
- Efficacy at 100lm/W
- High uniformity of Light that delivers wide light and uniform panel
- Equipped with flicker free driver in both options $UGR \leq 19$ and $UGR \leq 22$ avoid eye strain & discomfort
- Microprismatic diffuser options with $UGR \leq 19$, less glare to provide visual comfort
- Enhance product reliability which are manufactured by fully automatic assembly line
- Screwless assembly design which can reach IP40 rating
- Driver with loop through function to further enhance ease of installation
- Excellent quality of light guide panel materials deliver excellent lumen output throughout product life
- Easy Plug & Play connector
- Ceiling frame and surface mounting kits to cater different installation methods



Applications

- Conference rooms
- Offices
- Classrooms
- Corridors

Flicker Free Performance



Other LED panel with flicker



BERTO LED panel with flicker free and uniform lighting distribution

Screwless Assembly Design



Screwless design which reach IP40 rating

MEGAMAN® BERTO SIDELIT

FPL70300v1ex+LD226036-C0950

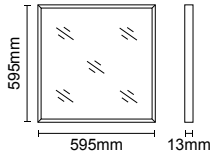

FPL70700v1-ex+LD226036-C0950

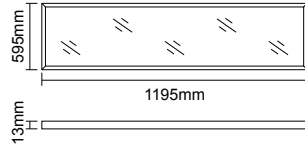

FPL70400v3-ex+LD226036-C0950
FPL70400v4-ex/tb+LD230036/mc-C0950

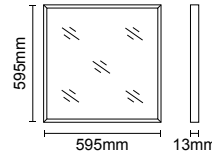

FPL70500v1-ex+LD226036-C0950
FPL72800v0-ex/tb+LD227054-C1300

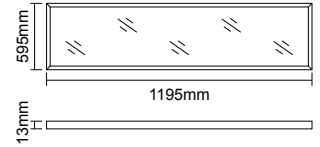

220-240V

White (WH26)

Model No.	Input Current (mA)	Luminaire Wattage (W)	System Wattage (W)	Luminous Flux (lm)	Luminous Efficacy (lm/W)	Beam Angle (°)	Dimension (mm)	Colour Temp. [CRI]	Rated Life (hrs)	Materials
UGR≤19										
FPL70300v1-ex+LD226036-C0950	950	32.4	36	3350 [3000K] 3600 [4000K/6500K]	93 [3000K] 100 [4000K/6500K]	90	W595 x L595 x H13	3000K/4000K/6500K [Ra80]	50,000hrs L80B10@ Ta25°C	Aluminium housing + PMMA LGP
FPL70700v1-ex+LD226036-C0950	950	32.4	36	3350 [3000K] 3600 [4000K/6500K]	93 [3000K] 100 [4000K/6500K]	90	W1195 x L595 x H13	3000K/4000K/6500K [Ra80]	50,000hrs L80B10@ Ta25°C	Aluminium housing + PMMA LGP
UGR≤22										
FPL70400v3-ex+LD226036-C0950	950	32.4	36	3350 [3000K] 3600 [4000K/6500K]	93 [3000K] 100 [4000K/6500K]	110	W595 x L595 x H13	3000K/4000K/6500K [Ra80]	50000 (L70 B50@ Ta25°C)	Aluminium housing + PS
FPL70500v1-ex+LD226036-C0950	950	32.4	36	3350 [3000K] 3600 [4000K/6500K]	93 [3000K] 100 [4000K/6500K]	110	W1195 x L595 x H13	3000K/4000K/6500K [Ra80]	50000 (L70 B50@ Ta25°C)	Aluminium housing + PS
FPL70400v4-ex/tb+LD230036/mc-C0950	950	36	36	3350 [3000K] 3600 [4000K/6500K]	93 [3000K] 100 [4000K/6500K]	110	W595 x L595 x H13	3000K/4000K/6500K [Ra80]	50000 (L70 B50@ Ta25°C)	Aluminium housing + PS
FPL72800v0-ex/tb+LD227054-C1300	1300	50	54	5000 [4000K/6500K]	100 [4000K/6500K]	110	W1195 x L595 x H13	3000K/4000K/6500K [Ra80]	50000 (L70 B50@ Ta25°C)	Aluminium housing + PS

Accessory



LA6039
Loophrough adaptor for LD230036/mc-C0950 LD226036-C0750



LA10139
Surface Mounting frame 600 x 600mm



LA10140
Surface Mounting frame 620 x 620mm



LA10141
Surface Mounting frame 1200 x 300mm



LA10120
Safety kit, including 1.0m safety cable x1 V shape hooker x1 Screw ST4*9 x2

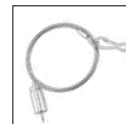

LA10121
Suspension kit, including 1.8m Type I cable x4 V shape hooker x4 Screw ST4*9 x8

MEGAMAN® BERTO SIDELIT

BERTO SIDELIT Photometric Data

FPL70300v1-ex+LD226036-C0950

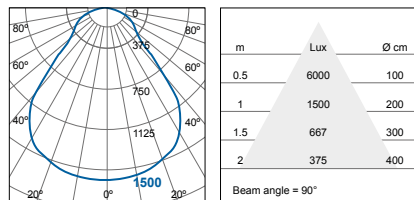

FPL70400v3-ex+LD226036-C0950

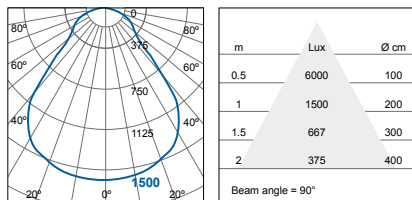

FPL70500v1-ex+LD226036-C0950

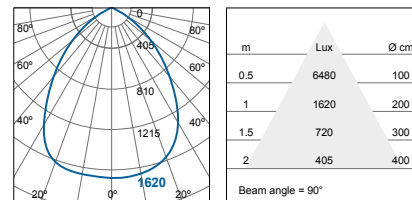

FPL70700v1-ex+LD226036-C0950

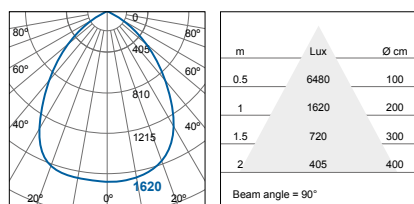

FPL72800v0-ex/tb+LD227054-C1300

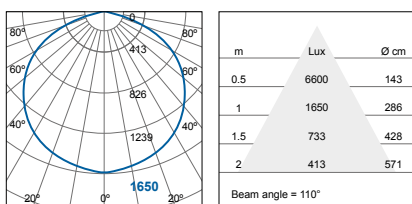

LD226036-C0950

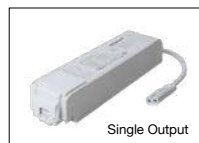

LD230036/mc-C0950

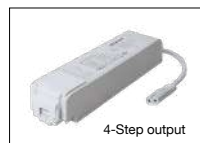

LD227054-C1300

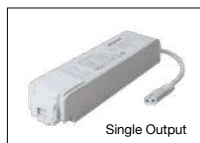

LD232037/da/mc-C0950



Driver Model	Main Voltage Input	Output Current (Constant) (mA)	Output Voltage Range (V)	System Power	Power Factor	Dimmability	Dimension (mm)	Cable Thickness Range (mm²)
LD226036-C0950	220-240 VAC	950	30-45	36	>0.9	Non-dimmable	L177.5 x W34 XH29	2 x (0.75 - 1.5mm2)
LD230036/mc-C0950	220-240 VAC	950/850/750/650	30-39	36/33/29/25	>0.9	Non-dimmable	L176 x W42.5 x H32	2 x (0.75 - 1.5mm2)
LD227054-C1300	220-240 VAC	1300	30-42	54	>0.9	Non-dimmable	L235 x W42.5 x H32	2 x (0.75 - 1.5mm2)
LD232037/da/mc-C0950	220-240 VAC	950	30-39	37	>0.9	DALI 2.0	L200 x W64 x H32	5 x (0.75 - 2.5mm2)

MEGAMAN® ESTELA 2



MEGAMAN® ESTELA 2



MEGAMAN® ESTELA 2

LED Panel



Features

- Perfect solution for office lighting with new generation of LED louvre panel
- Special double asymmetric optics deliver high level of uniformity of light in a workplace
- Exchangeable clipped-in LED modules offer flexibility to satisfy customers' requirement (e.g.: change of CCT, CRI, etc.) with short lead time
- External driver offers the flexible compatibility with ON/OFF driver with 4 lumen output or DALI dimming
- UGR19 with high cut off angle louvre
- Flicker free
- Long life time 50,000hrs L80B10 at Ta25°C
- Light in weight for easy installation

Applications

- Offices
- Department stores
- Schools

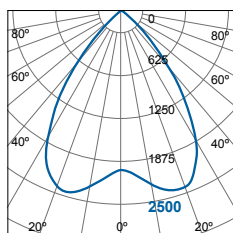

Double asymmetric photometric distribution for maximum uniformity



I-beam construction at the back plate for reinforcing the structural robustness and ensuring flatness of panel

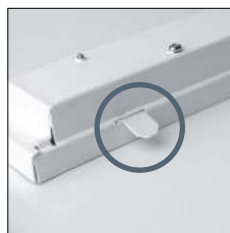

Interlocking system between the LED tray and metal plate

MEGAMAN® ESTELA 2

FPL73400v1-ex+LD220036/mc-C0950
FPL73600v1-ex+LD220036/mc-C0950

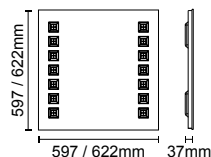

FPL73500v1-ex+LD220036/mc-C0950
FPL73700v1-ex+LD220036/mc-C0950

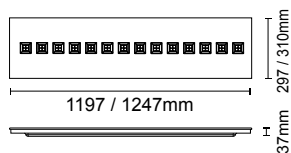

220-240V

White (WH26)

ON/ OFF driver with 4-lumen Output

Model No.	System Wattage (W)	Lumen (lm)	Lm/W	Dimension (mm)	Rated Life at L80 B10 at Ta25°C (hrs)	Materials
FPL73400v1-ex+LD220036/mc-C0950	36/32/28/24	3900/3580/3160/2800 [3000K] 4200/3850/3400/3000 [4000K]	108/112/113/117 [3000K] 117/120/121/125 [4000K]	W597 x L597 x H37	50000	PC/ PMMA Diffuser
FPL73500v1-ex+LD220036/mc-C0950	36/32/28/24	3900/3580/3160/2800 [3000K] 4200/3850/3400/3000 [4000K]	108/112/113/117 [3000K] 117/120/121/125 [4000K]	W297 x L1197 x H37	50000	PC/ PMMA Diffuser
FPL73600v1-ex+LD220036/mc-C0950	36/32/28/24	3900/3580/3160/2800 [3000K] 4200/3850/3400/3000 [4000K]	108/112/113/117 [3000K] 117/120/121/125 [4000K]	W622 x L622 x H37	50000	PC/ PMMA Diffuser
FPL73700v1-ex+LD220036/mc-C0950	36/32/28/24	3900/3580/3160/2800 [3000K] 4200/3850/3400/3000 [4000K]	108/112/113/117 [3000K] 117/120/121/125 [4000K]	W310 x L1247 x H37	50000	PC/ PMMA Diffuser

36W
FPL73400v1-ex+LD220036mc-C0950
FPL73500v1-ex+LD220036/mc-C0950
FPL73600v1-ex+LD220036/mc-C0950
FPL73700v1-ex+LD220036/mc-C0950

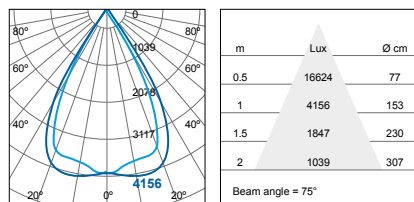

32W
FPL73400v1-ex+LD220036mc-C0950
FPL73500v1-ex+LD220036/mc-C0950
FPL73600v1-ex+LD220036/mc-C0950
FPL73700v1-ex+LD220036/mc-C0950

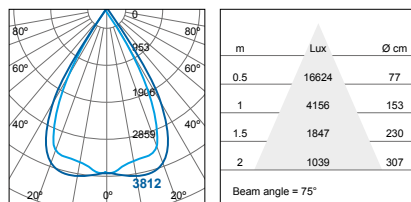

28W
FPL73400v1-ex+LD220036mc-C0950
FPL73500v1-ex+LD220036/mc-C0950
FPL73600v1-ex+LD220036/mc-C0950
FPL73700v1-ex+LD220036/mc-C0950

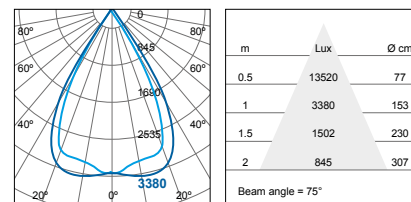

24W
FPL73400v1-ex+LD220036mc-C0950
FPL73500v1-ex+LD220036/mc-C0950
FPL73600v1-ex+LD220036/mc-C0950
FPL73700v1-ex+LD220036/mc-C0950

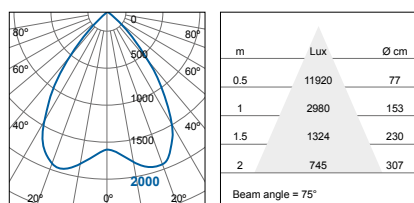

MEGAMAN® ESTELA 2

FPL73400v1-ex+LD232037/da/mc-C0950
FPL73600v1-ex+LD232037/da/mc-C0950

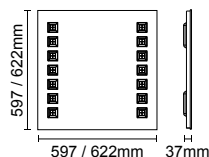
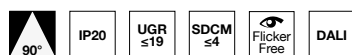

FPL73500v1-ex+LD232037/da/mc-C0950
FPL73700v1-ex+LD232037/da/mc-C0950

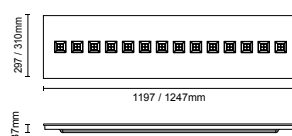

220-240V

White (WH26)

DALI Driver

Model No.	System Wattage (W)	Lumen (lm)	Lm/W	Dimension (mm)	Rated Life at L80 B10 at Ta25°C (hrs)	Materials
FPL73400v1-ex+LD232037/da/mc-C0950	36	3900 [3000K] 4200 [4000K/ 6500K]	108 [3000K] 117 [4000K]	W597 x L597 x H37	50000	PC/ PMMA Diffuser
FPL73500v1-ex+LD232037/da/mc-C0950	36	3900 [3000K] 4200 [4000K/ 6500K]	108 [3000K] 117 [4000K]	W297 x L1197 x H37	50000	PC/ PMMA Diffuser
FPL73600v1-ex+LD232037/da/mc-C0950	36	3900 [3000K] 4200 [4000K/ 6500K]	108 [3000K] 117 [4000K]	W622 x L622 x H37	50000	PC/ PMMA Diffuser
FPL73700v1ex+LD232037/da/mc-C0950	36	3900 [3000K] 4200 [4000K/ 6500K]	108 [3000K] 117 [4000K]	W310 x L1247 x H37	50000	PC/ PMMA Diffuser

MEGAMAN® BERTO BACKLIT

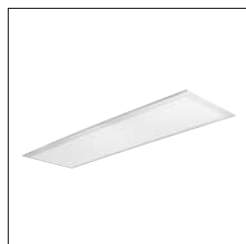

MEGAMAN® BERTO BACKLIT



MEGAMAN® BERTO BACKLIT

LED Panel

MEGAMAN® BERTO BACKLIT is an integrated lighting solution that facilitates easy installation and maintenance. It delivers a high luminous efficacy up to 120lm/W – matching the lighting levels of 3 x 18W T8 and 3 x 24W HE T5 fluorescent modular fittings.

These luminaires have a long life and provide uniform light distribution for general lighting applications. Microprismatic diffuser option with Unified Glare Rating (UGR) of ≤ 19 offers a high level of visual comfort and avoids fatigue to the eyes, ideal for use in offices, classrooms and corridors.

Features

- Backlit technology offers high uniformity of light output
- Equipped with flicker free driver in both options $UGR \leq 19^*$ and $UGR \leq 22$ avoid eye strain & discomfort
- Microprismatic diffuser options with $UGR \leq 19$, less glare to provide visual comfort
- Efficacy up to 110lm/W
- TP(a) rated thermoplastic diffuser as an option
- Long lifetime with 50,000hrs L70B50 @Ta 25°C
- Operating temperature -30°C to +45°C
- IP40 rated
- Easy Plug & Play connector
- Loop through adaptor enhance ease of installation

* $UGR \leq 19$ valid for 4000K-3600/3200/2800lm, $UGR \leq 20$ for 4000lm



Flicker Free



UGR ≤ 19



Up to 120 lm/W



50000 hrs

Applications

- Conference rooms
- Offices
- Classrooms
- Corridors

Flicker Free Performance



Other LED panel with flicker



BERTO LED panel with flicker free and uniform lighting distribution

MEGAMAN® BERTO BACKLIT

FPL71900v2ex+LD226036-C0800

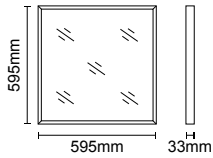

FPL71900v1-ex+LD230036/mc-C0950

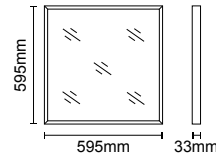

FPL71800v0-ex/ta+LD226036-C0750

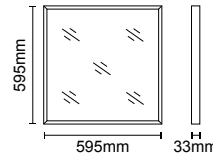

FPL73800v0-ex/ta+LD236046-C1100

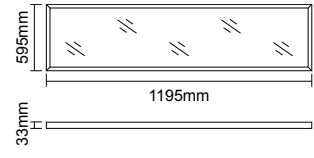

220-240V

White (WH26)

Model No.	Input Current (mA)	Luminaire Wattage (W)	System Wattage (W)	Luminous Flux (lm)	Luminous Efficacy (lm/W)	Beam Angle (°)	Dimension (mm)	Rated Life (hrs)	Materials
UGR≤19									
FPL71900v2-ex+LD226036-C0800	800	30	36	3350 [3000K] 3600 [4000K/6500K]	112 [3000K] 120 [4000K/6500K]	90	W595 x L595 x H33	50,000hrs L70B50@Ta25°C	Metal housing + microprismatic diffuser
FPL71900v1-ex+LD230036/mc-C0950	950	32/29/26/23	36/33/29/25	3700/3350/2950/2550 [3000K] 4000/3600/3200/2750 [4000K]	103/102/102/102 [3000K] 111/109/110/110 [4000K/6500K]	90	W595 x L595 x H33	50,000hrs L70B50@Ta25°C	Metal housing + microprismatic diffuser
UGR≤22									
FPL71800v0-ex/ta+LD226036-C0750	750	32.4	36	3350 [3000K] 3600 [4000K/6500K]	93 [3000K] 100 [4000K/6500K]	110	W595 x L595 x H33	50,000hrs L70B50@Ta25°C	Metal housing + PC diffuser
FPL73800v0-ex/ta+LD236046-C1100	1100	43	46	4560 [3000K] 5000 [4000K/6500K]	107 [3000K] 116 [4000K]	110	W1195 x L595 x H33	50,000hrs L70B50@Ta25°C	Metal housing + PC diffuser

FPL71900v1-ex+LD230036/mc-C0950

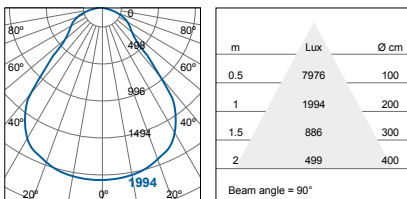

FPL71800v0-ex/ta+LD226036-C0750

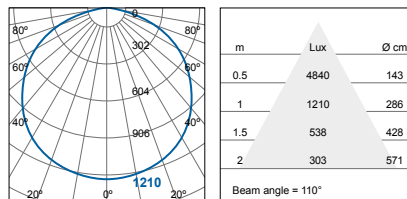

MEGAMAN® BERTO BACKLIT



LD226036-C0750

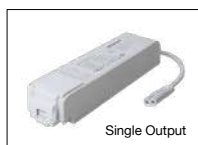

Single Output

LD226036-C0800

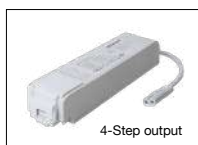

4-Step output

LD236046-C1100

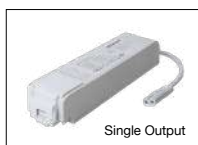

Single Output

LD230036/mc-C0950

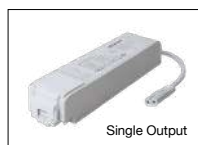

Single Output

LD232037/da/mc-C0950



DALI

Driver Model	Main Voltage Input	Output Current (Constant) (mA)	Output Voltage Range (V)	System Power	Power Factor	Dimmability	Dimension (mm)	Cable Thickness Range (mm ²)
LD226036-C0750	220-240 VAC	750	42	36	>0.9	Non-dimmable	L178 x W35 x H29	2 x (0.75 - 1.5mm ²)
LD226036-C0800	220-240 VAC	800	30-45	36	>0.9	Non-dimmable	L177.5 x W34 XH29	2 x (0.75 - 1.5mm ²)
LD236046-C1100	220-240 VAC	1100	55	46	>0.9	Non-dimmable	L235 x W43 H33	2 x (0.75 - 1.5mm ²)
LD230036/mc-C0950	220-240 VAC	950/850/750/650	30-39	36/33/29/25	>0.9	Non-dimmable	L176 x W42.5 x H32	2 x (0.75 - 1.5mm ²)
LD232037/da/mc-C0950	220-240 VAC	950	30-39	37	>0.9	DALI 2.0	L200 x W64 x H32	5 x (0.75 - 2.5mm ²)

Accessory



LA6039
Loopthrough adaptor for
LD230036/mc-C0950
LD226036-C0750



LA10120
Safety kit, including 1.0m
safety cable x1
V shape hooker x1
Screw ST4*9 x2



LA10121
Suspension kit, including
1.8m Type I cable x4
V shape hooker x4
Screw ST4*9 x8



LA8107
Surface mount frame
595 x 595mm

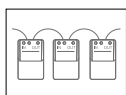

Loop through wiring

MEGAMAN® XAVIER

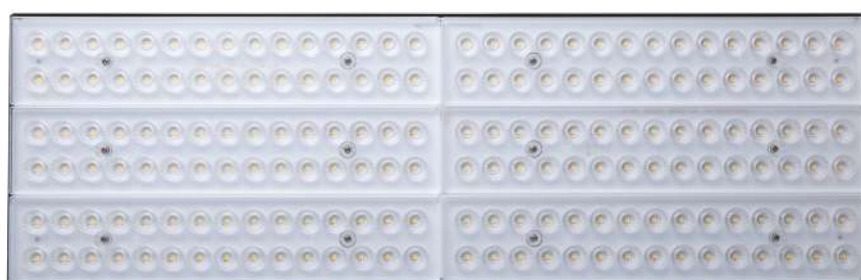

Indoor Lighting / LED Track Panel

MEGAMAN® XAVIER



MEGAMAN® XAVIER

LED Track Panel

Lighting play an important role in retail atmosphere to attract customers. MEGAMAN® Xavier is a complete Track system especially design for shop and retail application. Thanks for the optimized LED system and modular optics design, Xavier delivers up to 9600lm with variety beam angle to ensure the perfect light distribution and uniformity on the aisle between shelves to enhance the shopping experience. 3-phase track mounting system provide high efficiency on installation and high flexibility for repositioning along the track.

Features

- Modular optic system offers the flexibility for the beam angle
- Double Asymmetrical & lambertian distribution
- The optics modules design for "ready to change", it enhance the flexibility of light requirement
- Slim design and light in weight
- Dual power for different lumen output
- High lumen output up to 9600lm
- Superb efficacy up to 160lm/W
- Long life time 50,000hrs L80B10@Ta25°C
- More flexible when compared with the trucking system
- 3-phase connection track adaptor
- DALI dimming will be available soon



Applications

- Retails
- Supermarkets
- Warehouses and similar applications

MEGAMAN® XAVIER

FTK71700v0-ds+090D
 FTK71700v0-ds+028A028A
 FTK71700v1-da+090D
 FTK71700v1-da+028A028A

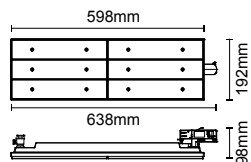

220-240V

Black (BK12)

Model No.	Wattage (W)	Luminous Flux (lm)	Lm/W	Beam Angle	Colour Temp.	CRI	Dimension (mm)	Rated Life at L80 B10 at Ta25°C (hrs)	Materials
FTK71700v0-ds+090D	60/44	7700/5600 [3000K] 8400/6200 [4000K/6500K]	128/127 [3000K] 140/141 [4000K/6500K]	90°	3000K/4000K/ 6500K	≥80	W190 x L598 x H97	50000	PMMA Diffuser + Polycarbonate Housing
FTK71700v0-ds+028A028A	60/44	7700/5600 [3000K] 8400/6200 [4000K]	128/127 [3000K] 140/141 [4000K/6500K]	Double asymmetrical	3000K/4000K/ 6500K	≥80	W190 x L598 x H97	50000	PMMA Diffuser + Polycarbonate Housing
FTK71700v1-da+090D*	60	8900 [3000K] 9600 [4000K/6500K]	148 [3000K] 160 [4000K/6500K]	90°	3000K/4000K/ 6500K	≥80	W190 x L598 x H97	50000	PMMA Diffuser + Polycarbonate Housing
FTK71700v1-da+028A028A*	60	8900 [3000K] 9600 [4000K/6500K]	148 [3000K] 160 [4000K/6500K]	Double asymmetrical	3000K/4000K/ 6500K	≥80	W190 x L598 x H97	50000	PMMA Diffuser + Polycarbonate Housing

* DALI dimming will be available soon

FTK71700v0-ds+028A028A-840-V0240(44W)

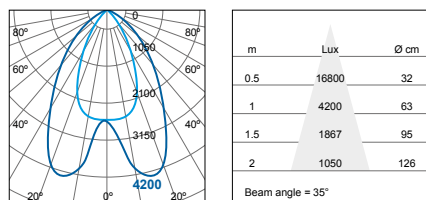

FTK71700v0-ds+028A028A-840-V0240(60W)

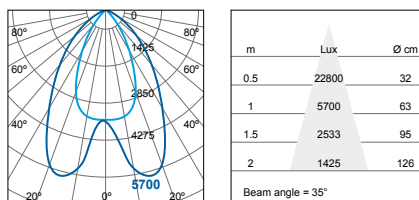

FTK71700v0-ds+090D-840-V240(44W)

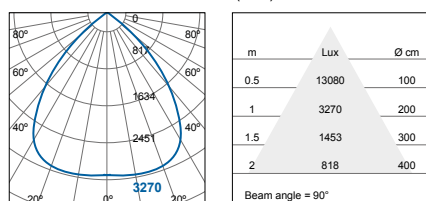

FTK71700v0-ds+090D-840-V240(60W)

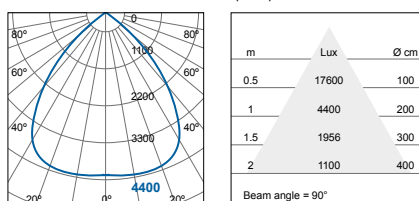

Indoor Lighting / LED Track Panel
MEGAMAN® XAVIER



MEGAMAN® MARCO 2



NEW



MEGAMAN® MARCO 2



MEGAMAN® MARCO 2

Integrated LED Tracklight

MEGAMAN® MARCO 2 is designed by driver on adaptor, which enhance heat dissipation function effectively. Thanks for MEGAMAN® the Dual Beam Technology (DBT), it is dedicated the flexibility of beam angles in one single luminaire and help to facilitate inventory management. DBT is an innovative approach for switching the size of the light spot with a finger press on lens. With this technology one can shape the light spot of the lamp / luminaire from a narrow beam angle to a wider beam angle. In addition high CRI90 options are also available within the range.

Features

- Driver on adaptor design enhance heat dissipation function effectively
- Combined MEGAMAN® patented Dual Beam Technology (DBT), capable to switching two beam angles in one luminaire
- Offers the flexibility of changing the beam angle on site, beneficial to lighting designers & visual merchandisers to cater different scene setting
- Enable keep less stock and reduce the storage space & management
- Excellent colour rendering index of 90
- High efficacies up to 100lm/W
- High colour consistency SDCM ≤ 3
- Long life 50,000hrs at L70B50 at Ta25°C

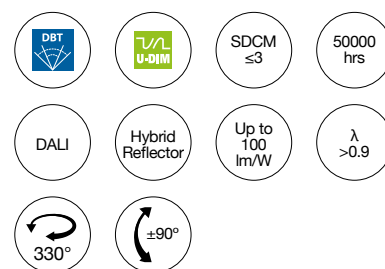

Applications

- Shop lighting
- Hotels
- Showrooms
- Restaurants
- Museums

MEGAMAN® MARCO 2 MINI

FTK73000v0-db+024D036D
FTK73000v0-db/r9+024D036D

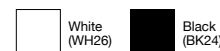
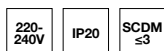
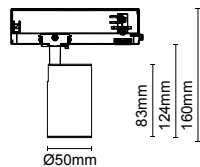

Standard Version

Model No.	Wattage (W)	Luminous Flux (lm)	Luminous Efficacy (lm/W)	Beam Angle (°)	Max. Luminous Intensity (cd)	Dimension (mm)	Colour Temp. [CRI]	Rated Life at L70 B50 at Ta25°C (hrs)	Power Factor (λ)	Material
FTK73000v0-db+024D036D	12	1100 [3000K] 1200 [4000K]	92 [2800K] 100 [4000K]	24 / 36	6000 [24°] 3000 [36°]	Ø50 x L160	3000K/4000K [≥Ra80]	50000	>0.9	Aluminium
FTK73000v0-db/r9+024D036D	12	1100 [3000K] 1200 [4000K]	92 [2800K] 100 [4000K]	24 / 36	6000 [24°] 3000 [36°]	Ø50 x L160	3000K/4000K [Ra90]	50000	>0.9	Aluminium

DALI Version

Model No.	Wattage (W)	Luminous Flux (lm)	Luminous Efficacy (lm/W)	Beam Angle (°)	Max. Luminous Intensity (cd)	Dimension (mm)	Colour Temp. [CRI]	Rated Life at L70 B50 at Ta25°C (hrs)	Power Factor (λ)	Material
FTK73000v0-da/db+024D036D	12	1100 [3000K] 1200 [4000K]	92 [2800K] 100 [4000K]	24 / 36	6000 [24°] 3000 [36°]	Ø50 x L160	3000K/4000K [≥Ra80]	50000	>0.9	Aluminium
FTK73000v0-da/db/r9+024D036D	12	1100 [3000K] 1200 [4000K]	92 [2800K] 100 [4000K]	24 / 36	6000 [24°] 3000 [36°]	Ø50 x L160	3000K/4000K [Ra90]	50000	>0.9	Aluminium

Accessory



LA10181
Honeycomb louvre

Indoor Lighting / Track Lighting

MEGAMAN® MARCO 2 MIDI

FTK73100v0-db+025D045D
FTK73100v0-db/r9+025D045D

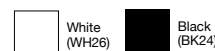
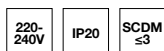
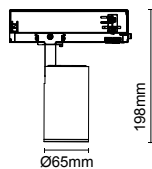

Standard Version

Model No.		Wattage (W)	Luminous Flux (lm)	Luminous Efficacy (lm/W)	Beam Angle (°)	Max. Luminous Intensity (cd)	Dimension (mm)	Colour Temp. [CRI]	Rated Life at L70 B50 at Ta25°C (hrs)	Power Factor (λ)	Material
FTK73100v0-db+025D045D		24	2300 [3000K] 2400 [4000K]	96 [2800K] 100 [4000K]	25 / 45	4300 [25°] 12000 [45°]	Ø65 x L198	3000K/4000K [≥Ra80]	50000	>0.9	Aluminium
FTK73100v0-db/r9+025D045D		24	2300 [3000K] 2400 [4000K]	96 [2800K] 100 [4000K]	25 / 45	4300 [25°] 12000 [45°]	Ø65 x L198	3000K/4000K [Ra90]	50000	>0.9	Aluminium

DALI Version

Model No.		Wattage (W)	Luminous Flux (lm)	Luminous Efficacy (lm/W)	Beam Angle (°)	Max. Luminous Intensity (cd)	Dimension (mm)	Colour Temp. [CRI]	Rated Life at L70 B50 at Ta25°C (hrs)	Power Factor (λ)	Material
FTK73100v0-da/db+025D045D		24	2300 [3000K] 2400 [4000K]	96 [2800K] 100 [4000K]	25 / 45	4300 [25°] 12000 [45°]	Ø65 x L198	3000K/4000K [≥Ra80]	50000	>0.9	Aluminium
FTK73100v0-da/db/r9+025D045D		24	2300 [3000K] 2400 [4000K]	96 [2800K] 100 [4000K]	25 / 45	4300 [25°] 12000 [45°]	Ø65 x L198	3000K/4000K [Ra90]	50000	>0.9	Aluminium

Accessory



LA10181
Honeycomb louvre

MEGAMAN® MARCO 2 90

FTK73200v0-db+025D045D
FTK73200v0-db/r9+025D045D

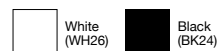
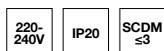
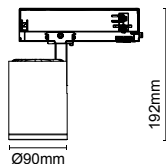

Standard Version

Model No.	Wattage (W)	Luminous Flux (lm)	Luminous Efficacy (lm/W)	Beam Angle (°)	Max. Luminous Intensity (cd)	Dimension (mm)	Colour Temp. [CRI]	Rated Life at L70 B50 at Ta25°C (hrs)	Power Factor (λ)	Material
FTK73200v0-db+025D045D	36	3400 [3000K] 3600 [4000K]	96 [2800K] 100 [4000K]	25 / 45	7000 [24°] 18000 [36°]	Ø90 x 192	3000K/4000K [≥Ra80]	50000	>0.9	Aluminium
FTK73200v0-db/r9+025D045D	36	3400 [3000K] 3600 [4000K]	96 [2800K] 100 [4000K]	25 / 45	7000 [24°] 18000 [36°]	Ø90 x 192	3000K/4000K [≥Ra80]	50000	>0.9	Aluminium

DALI Version

Model No.	Wattage (W)	Luminous Flux (lm)	Luminous Efficacy (lm/W)	Beam Angle (°)	Max. Luminous Intensity (cd)	Dimension (mm)	Colour Temp. [CRI]	Rated Life at L70 B50 at Ta25°C (hrs)	Power Factor (λ)	Material
FTK73200v0-da/db+025D045D	36	3400 [3000K] 3600 [4000K]	96 [2800K] 100 [4000K]	25 / 45	7000 [24°] 18000 [36°]	Ø90 x 192	3000K/4000K [≥Ra80]	50000	>0.9	Aluminium
FTK73200v0-da/db/r9+025D045D	36	3400 [3000K] 3600 [4000K]	96 [2800K] 100 [4000K]	25 / 45	7000 [24°] 18000 [36°]	Ø90 x 192	3000K/4000K [≥Ra80]	50000	>0.9	Aluminium

Accessory

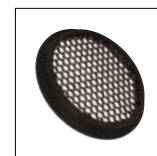

LA10181
Honeycomb louvre

MEGAMAN® MARCO 2





MEGAMAN® MORA

LED Tracklight

When utilizing the latest MEGAMAN® PAR16 LED reflector lamp technology with highly efficient optics, MEGAMAN® MORA is a very low energy track light compared with halogen sources. The upgraded construction of MEGAMAN® MORA also allows compatibility with most LED PAR16 lamps on the market. MEGAMAN® MORA has adjustable 90° tilt and 330° rotation angles, providing a cost effective multidirectional lighting solution ideal for common accent lighting applications.

Features

- Compact serviceable GU10 tracklight
- Compatible to most of the market LED PAR16 Lamp
- Adjustable arm for multi-directional lighting: 330° horizontal rotation and 90° vertical tilting angle
- 3 circuit track adaptor as standard compatible with most 3 circuit systems
- Single phase track adaptor version available



Applications

- Shops and boutiques
- Hotels
- Restaurants
- Homes

Indoor Lighting / Track Lighting
MEGAMAN® MORA

FTK70317v0 / FTA70317v0 /
 FTS70317v0

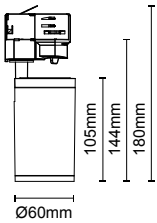

220-
240V



Model No.	Max. Wattage (W)	Dimension (mm)	Light Source	Lamp Base	Materials
FTK70317v0	7.2	Ø60 x H180	LED PAR16	GU10	Polycarbonate
FTA70317v0	7.2	Ø60 x H163	LED PAR16	GU10	Polycarbonate
FTS70317v0	7.2	Ø60 x H163	LED PAR16	GU10	Polycarbonate

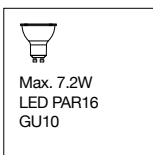



MEGAMAN® MOSAIC

LED Tracklight

MEGAMAN® MOSAIC is a compact adjustable fitting for use with LED PAR16 reflectors to replace halogen in accent lighting applications – offering excellent light output with up to 25,000 hours lifetime.

With adjustable 330° rotation and 90° tilt angles, MEGAMAN® MOSAIC provides a flexible multidirectional lighting solution that is ideal for accent lighting applications. MEGAMAN® MOSAIC offers visual comfort with minimal glare.

Features

- Flexible multi-directional lighting: adjustable 330° rotation and 90° tilt angle, Ideal for use in galleries, restaurants, showrooms, hotels, retail outlets, reception areas, etc.
- Offers visual comfort with minimal glare
- Adjustable lamp holder for easy installation
- Offers two installation methods: track and surface mounted
- Track version has 3 circuit track adaptor as standard compatible with most 3 circuit systems
- Asian track adaptor version available



Applications

- Galleries
- Restaurants
- Showrooms
- Hotels
- Retail outlets
- Reception areas



Indoor Lighting / Track Lighting
MEGAMAN® MOSAIC

F11517TA / F11517TK

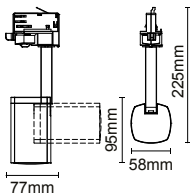

F11517SM

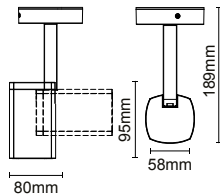

220-240V

White (WH12) Silver (SV22) Black (BK12)

Model No.	Max. Wattage (W)	Dimension (mm)	Light Source	Lamp Base	Materials
F11517TA	14	W58 x L77x H193	LED PAR16	GU10	Polycarbonate
F11517TK	14	W58 x L77x H225	LED PAR16	GU10	Polycarbonate
F11517SM	14	W58 x Ø80 x H189	LED PAR16	GU10	Polycarbonate

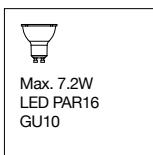



MEGAMAN® TOBY

LED Tracklight

MEGAMAN® TOBY has a stylish finishing with aluminium material and uses an LED AR111 reflector to offer superb high lumen intensity and up to 40,000 hours service lifetime, which is perfect for the conventional halogen AR111 application replacement.

Designed for adjustable 340° rotation and 170° tilt angles, MEGAMAN® TOBY allows for multidirectional lighting. It is perfect for use in any retail outlet, hotel, restaurant, gallery or residential applications.

Features

- Designed to replace conventional halogen applications, MEGAMAN® TOBY uses a stylish finishing with aluminium material and works with LED AR111 to offer up to 40,000 hours service lifetime
- Flexible multi-directional lighting with adjustable 340° rotation and 170° tilt angles
- Track version has 3 circuit track adaptor as standard compatible with most 3 circuit systems
- Asian track adaptor version available



Applications

- Retail outlets
- Hotels
- Restaurants
- Galleries
- Residential applications



Indoor Lighting / Track Lighting
MEGAMAN® TOBY

F13117TK / F13117TA

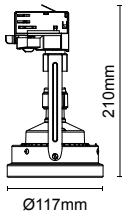

220-240V

F13117SM

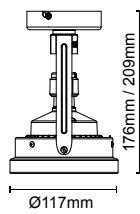

White (WH21) Silver (SV23) Black (BK21)

Model No.	Max. Wattage (W)	Dimension (mm)	Light Source	Lamp Base	Materials
F13117TK / F13117TA	11.5	Ø117 x H210	LED AR111	GU10	Steel



MEGAMAN® TRAVIS



MEGAMAN® TRAVIS

LED Trunking

MEGAMAN® TRAVIS is a complete trunking system with unobtrusive design that enables the creation of continuous lines of light for ceiling fixing or suspended mounting on wire or chains. It is designed for fast and tool-less mechanical and electrical installation.

Features

- Luminaires trunking systems offer numerous lighting combinations to form a continuous lines of light, which perfectly illuminates all commercial area, industrial area, etc.
- A trunking solution specially designed to boost productivity and enhance shopping experience without lighting performance and energy efficiency
- Both trunking and track mounted version available for selection
- MEGAMAN® TRAVIS enables quick tool-less assembly and fast installation with: "Turn and Lock" feature enables quick, easy and tool-less installation, with design compatible with major brand's mounting rails
- Electrical power can be instantly connected by a quick connector
- Unobtrusive design with built-in through wire system in luminaires with the accessory options to fit different projects
- Available in 120° to offer general lighting
- Efficient system up to 140lm/W
- High lumen output of up to 9000lm

50000 hrs

Up to 140 lm/W

Applications

- Production Plant
- Warehouse
- Supermarket







Indoor Lighting / LED Trunking

MEGAMAN® TRAVIS

TRAVIS Gen2

220-240V -20°C to +45°C 50/60Hz





 White

Model No.	Wattage (W)	Luminous Flux (lm)	Luminous Efficacy (lm/W)	Beam Angle (°)		Dimension (mm)	Rated Life at L80 B10 at Ta25°C (hrs)	Colour Temp [CRI]
FTL74000v0+120D	28	3600 [3000K] 4000 [4000K/ 6500K]	129 [3000K] 140 [4000K/6500K]	120		1482(L)×72(W)×54(H)	50000	3000K/4000K/ 6500K [Ra80]
FTL74000v1+120D	50	6300 [3000K] 7000 [4000K/ 6500K]	126 [3000K] 140 [4000K/6500K]	120		1482(L)×72(W)×54(H)	50000	3000K/4000K/ 6500K [Ra80]
FTL74000v2+120D	65	8200 [3000K] 9100 [4000K/ 6500K]	126 [3000K] 140 [4000K/6500K]	120		1482(L)×72(W)×54(H)	50000	3000K/4000K/ 6500K [Ra80]

TRAVIS Gen2 (Track Version)

220-240V -20°C to +45°C 50/60Hz

 White

Model No.	Wattage (W)	Luminous Flux (lm)	Luminous Efficacy (lm/W)	Beam Angle (°)		Dimension (mm)	Rated Life at L80 B10 at Ta25°C (hrs)	Colour Temp [CRI]
FTK71200v0+120D	28	3600 [3000K] 4000 [4000K/ 6500K]	129 [3000K] 140 [4000K/6500K]	120		1482(L)×72(W)×54(H)	50000	3000K/4000K/ 6500K [Ra80]
FTK71200v1+120D	50	6300 [3000K] 7000 [4000K/ 6500K]	126 [3000K] 140 [4000K/6500K]	120		1482(L)×72(W)×54(H)	50000	3000K/4000K/ 6500K [Ra80]
FTK71200v2+120D	65	8200 [3000K] 9100 [4000K/ 6500K]	126 [3000K] 140 [4000K/6500K]	120		1482(L)×72(W)×54(H)	50000	3000K/4000K/ 6500K [Ra80]

Accessory



LA10155
Mounting rail
end cover



LA10156
Mounting rail
connecting
piece



LA10157
2pcs 1.5m
suspension
cable



LA10158
Fixing
bracket



LA10159
Mounting
rail L-type
connecting piece



LA10160
Mounting rail
T-type connecting
piece



LA10161
Mounting rail
cross connecting
piece



LA10162
Fixing hook
for chain



LA10163
1.5m Blinding
plate

MEGAMAN® KETO CCT



MEGAMAN® KETO CCT



MEGAMAN® KETO CCT

Under Cabinet

MEGAMAN® KETO CCT is an ideal luminaire range for indoor applications for residential lighting not only delivering a significant lighting performance but also with switching colour function. This luminaire with the Hexagon shape design is able to be mounted for 45° applications. MEGAMAN® KETO CCT is easy to handle as the integrated driver and built-in LED facilitates easy installation.

Features:

- True replacement for traditional T5 & T8 battens
- Switching CCT (3000K / 4000K) by sliding switching
- Integrated driver and built-in LED facilitates easy installation Hexagon shape design with inclined base to be mounted for 45° application
- Two electrical sockets with the luminaire for the power supply for other appliances



Applications

- Under cabinet
- Staircases
- Corridors
- Kitchens

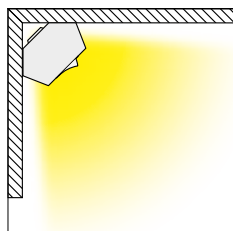

The base is inclined, so MEGAMAN® KETO can be mounted at 45° under cabinets



Two electrical sockets for supply of appliances

MEGAMAN® KETO CCT

FIB75200v0-sc

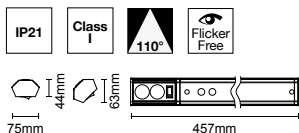

FIB75300v0-sc

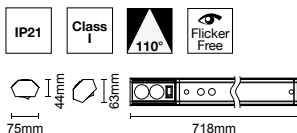

FIB75400v0-sc

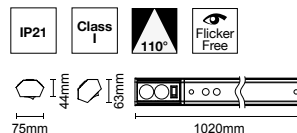

220-240V

White (WH26)

Model No.	Wattage (W)	Luminous Flux (lm)	Beam Angle (°)	Dimension (mm)	Colour Temp. [CRI]	Rated Life at L70 B50 at Ta25°C (hrs)	Power Factor (λ)	Materials
FIB75200v0-sc	4.5	500 / 540	110	L457 x W75 x H44	3000K / 4000K	40000	>0.7	Polycarbonate housing + Polycarbonate diffuser
FIB75300v0-sc	10.5	1200 / 1300	110	L718 x W75 x H44	3000K / 4000K	40000	>0.9	Polycarbonate housing + Polycarbonate diffuser
FIB75400v0-sc	13.5	1500 / 1600	110	L1020 x W75 x H44	3000K / 4000K	40000	>0.9	Polycarbonate housing + Polycarbonate diffuser

FIB75200v0-sc

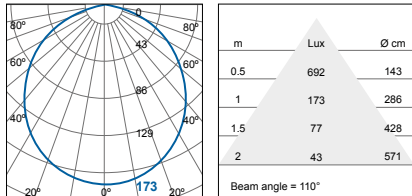

FIB75300v0-sc

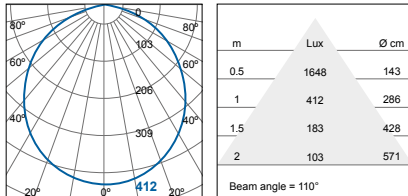

FIB75400v0-sc

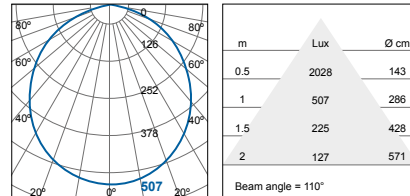

MEGAMAN® KETO CCT





MEGAMAN® PALMLITE

Downlight

With the ultra slim design, MEGAMAN® PALMLITE is designed for LED GX53 to offer up to 25,000 hours lifetime for slim surface mounted and conventional recessed applications.

MEGAMAN® PALMLITE eliminates problems associated with halogen lamps, where heat emanating from the lamps can cause damage to furniture and display items. Interchangeable circular rings are available to allow for matching with different furniture colours and finishes.

Features

- MEGAMAN® PALMLITE is designed to work with LED GX53 for slim surface mounted and conventional recessed applications
- Integral cabinet lighting with GX53 lamp holder
- Ultra slim design: the luminaire height is only 18mm
- Eliminates problems of heat damage to furniture and display items
- Interchangeable circular rings for matching with furniture and decoration
- Has options for different types of supply terminations

Applications

- Cabinets
 - Shelves
 - Workstations
 - Showcase displays
-

Indoor Lighting / Under Cabinet

MEGAMAN® PALMLITE

L0501CB



IP20 Class II

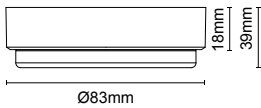

220-240V

White (WH11) Silver (SV22) Black (BK11) Gold (GD41)

Model No.	Max. Wattage (W)	Dimension (mm)	Light Source	Lamp Base	Materials
L0501CB	13	Ø83 x Max. H39	LED GX53	GX53	Polycarbonate

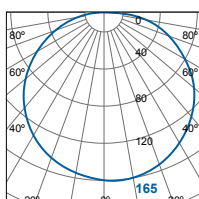
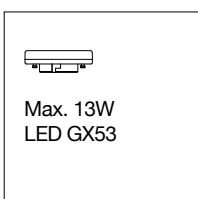

MEGAMAN® KARINA



MEGAMAN® KARINA



MEGAMAN® KARINA

Under Cabinet

MEGAMAN® KARINA is a versatile auxiliary lighting for furniture installation in kitchen, wardrobe or under cabinet. It comes with ultra-slim design with 24mm height only. MEGAMAN® KARINA is a touch-less ON/OFF control batten via motion sensor which offers an obvious upgrade for indoor lighting.

Features

- Ultra-slim design with 24mm height, it is perfect for under cabinet installation
- Tool-less wiring connection design
- Touch-less ON/OFF control thanks to the motion sensor
- 2 different finishing (White & Silver-grey)
- Wide light-emitting area
- True replacement for traditional T5 & T8 Battens

Accessory



Applications

- Under cabinet
- Staircases
- Wardrobes
- Kitchen

MEGAMAN® KARINA

FIB76000v0-ps

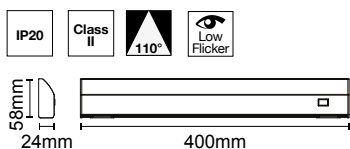

FIB76100v0-ps

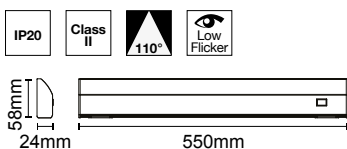

220-240V

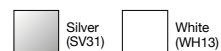

Model No.	Wattage (W)	Luminous Flux (lm)	Luminous Efficacy (lm/W)	Beam Angle (°)	Dimension (mm)	Colour Temp. [CRI]	Rated Lifetime L70B50@Ta25°C	Materials
FIB76000v0-ps	6	530 [3000K] 560 [4000K]	88 [3000K] 93 [4000K]	110	L400 x W58 x H24	3000K / 4000K	25000	Plastic housing and Plastic diffuser
FIB76100v0-ps	8.2	780 [3000K] 820 [4000K]	95 [3000K] 100 [4000K]	110	L550 x W58 x H24	3000K / 4000K	25000	Plastic housing and Plastic diffuser

FIB76000v0-ps (3000K)

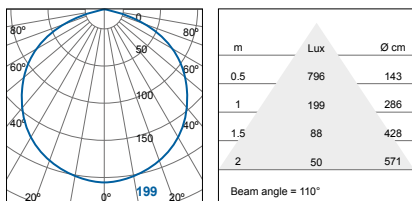

FIB76100v0-ps (3000K)

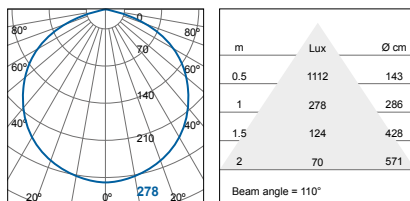

FIB76000v0-ps (4000K)

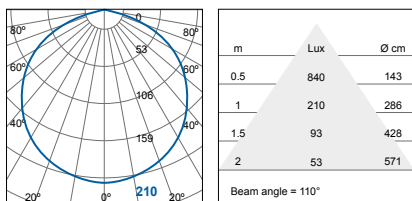

FIB76100v0-ps (4000K)

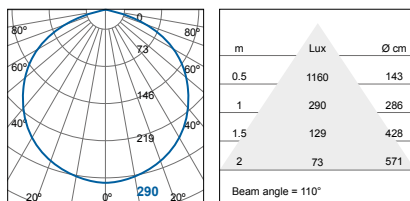

MEGAMAN® KARINA



MEGAMAN® EMMA



Indoor Lighting / LED Wall Lamp
MEGAMAN® EMMA



MEGAMAN® EMMA

Integrated LED Wall Lamp

MEGAMAN® EMMA is an integrated LED Wall Lamp with IP44 protection class easy withstand for the moisture in bathrooms and damp locations. Brilliant design with dual CCT function with 3-steps switching via IR sensor cater for different scenes setting. Easy installation for wall mounted or mounted with bracket on the cabinet enhance the flexibility.

Features

- Dual CCT function with 3-steps scene switching via IR sensor
- 2 installation methods including Wall mounted and Mounted on cabinet with bracket
- IP44 protection
- Operation temperature -20°C to +40°C

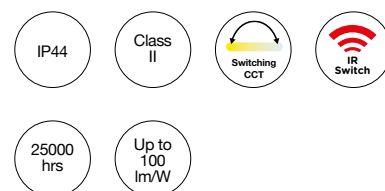

Applications

- Bathrooms
- Corridors
- Residential
- Hotels

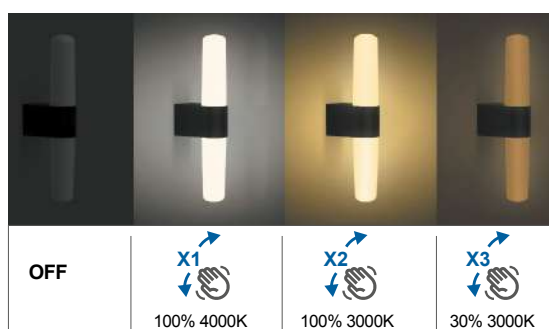

MEGAMAN® EMMA

FWL70500v0-ds/ps/sc

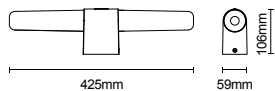

220-240V



Model No.	Wattage (W)	Luminous Flux (lm)	Beam angle (°)	3-step scene switching	Colour Temp. [CRI]	Dimension (mm)	Rated Life at L70B50 at Ta25°C (hrs)	Materials
FWL70500v0-ds/ps/sc 	9	900	360	Step 1 : 4000K @ 100% Step 2 : 3000K @ 100% Step 3 : 3000K @ 30%	3000K /4000K [80]	L425 x W59 x H106	25000	PC diffuser and Plastic housing

Cabinet bracket included

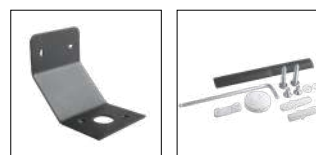

Indoor Lighting / Integrated LED Batten
MEGAMAN® EMMA





MEGAMAN® JUPITER

Mirror Light

MEGAMAN® JUPITER mirror light in style design with different lengths for customizable to suit personal preferences and decor. MEGAMAN® JUPITER with multi-mounting methods including straddle mounted on top of mirror, mounted on the furnitures or wall-mounted offer the flexibility and versatile options for mounting which is an ideal choice for bathrooms and bedrooms.

Features

- Multi-mounting methods: straddle mounted on top of mirror, mounted on the furnitures or wall-mounted
- 3 different lengths for versatile application
- 3 housing colour to suit personal preferences and décor
- Easy connection for friendly installation

Multi-mounting methods

1. Straddle mounted on top of mirror
2. Mounted on the furnitures
3. Wall-mounted



Applications

- Bathroom
- Bedroom
- Residential application
- Hotels

Indoor Lighting / Mirror Light
MEGAMAN® JUPITER

FWL70800v0



IP44

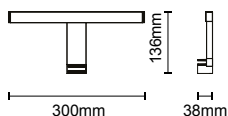

FWL70900v0



IP44

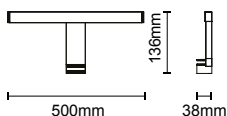

FWL71000v0



IP44

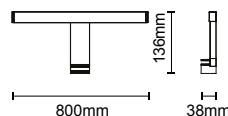

220-240V



Model no.	Wattage (W)	Luminous Flux (lm)	Colour temp. [CRI]	Dimension (mm)	Rated Life at L70 B50 at Ta25°C (hrs)	Dimmable	Housing color
FWL70800v0	9	900	3000K/4000K/6500K	L300 x W136 x H38	25000	non-dim	Black / White / Chrome
FWL70900v0	13	1350	3000K/4000K/6500K	L500 x W136 x H38	25000	non-dim	Black / White / Chrome
FWL71000v0	16	1700	3000K/4000K/6500K	L800 x W136 x H38	25000	non-dim	Black / White / Chrome



MEGAMAN® MARS

Mirror Light

MEGAMAN® MARS mirror light produces a bright and even lighting which is perfect for personal grooming. The even lighting is particularly beneficial to eliminate shadows or glare to see the reflection in the mirror. MEGAMAN® MARS with scenes setting feature via wall switch with memory function according to preference and need for creating the perfect ambience for different occasions.

Features

- Scenes setting via wall switch with memory function
- 3 scenes setting to create different mood
- Easy connection for friendly installation



Applications

- Bathroom
- Bedroom
- Residential application
- Hotels



Indoor Lighting / Mirror Light

MEGAMAN® MARS

FWL70700v0-ss



IP44 Ra90

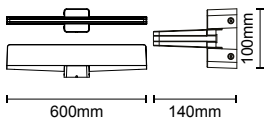

220-240V

White (WH26) Black (BK12)

Model No.	Max. Wattage (W)	Luminous Flux (lm)	Colour temp. [CRI]	Dimension (mm)	Rated Life at L70 B50 at Ta25°C (hrs)	Scenes setting	Housing colour
FWL70700v0-ss	24	1800	3000K and 4000K	L600 x W140 x H100	25000	100% @ 4000K 100% @ 3000K 20% @ 3000K	Black/BK12 White/WH26





MEGAMAN® VENUS

Mirror Light

MEGAMAN® VENUS mirror light enhances the beauty and functionality of living space, not only provide lighting but also add a touch of elegance and style to any space. MEGAMAN® VENUS with multi-mounting methods including straddle mounted on top of mirror or wall-mounted offer the flexibility and versatile options for mounting which is perfect for bathrooms, dressing rooms, bedrooms and even commercial spaces like spas and salons to enhance the decor while providing functional lighting. They can be hung on the wall or used as freestanding mirrors, depending on your preferences and the layout of your room. The lighting provided by LED mirrors can be adjusted to suit different needs, making them an excellent option for various applications.

Features

- Multi-mounting methods: straddle mounted on top of mirror or wall-mounted
- Easy connection for friendly installation



Applications

- Bathroom
- Bedroom
- Residential application
- Hotels
- Commercial spaces like spas or salons



Wall-mounted



Straddle mounted on top of mirror

Indoor Lighting / Mirror Light
MEGAMAN® VENUS

FWL71100v0



IP44

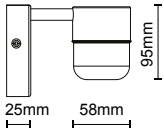

220-240V

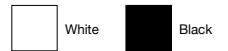

Model no.	Wattage (W)	Luminous Flux (lm)	Colour temp. [CRI]	Dimension (mm)	Rated Life at L70 B50 at Ta25°C (hrs)	Dimmable	Housing color
FWL71100v0	6.5	600	3000K / 4000K / 6500K	L130 x W95 x H58	25000	non-dim	Black / White

Indoor Lighting / Water Proof Batten

MEGAMAN® TARON



Indoor Lighting / Water Proof Batten

MEGAMAN® TARON



MEGAMAN® TARON

Integrated Water Proof Batten

To continue the successful story of our existing integrated water proof LED batten, MEGAMAN® comes up with the newly developed MEGAMAN® TARON with its flicker free, dual lumen output, 4-pole through-wiring allowing not only the connection of emergency and PIR Sensor module, but also enable for forming more than 1 group master/ slave in PIR sensor module (LA11155).

Features

- Compact and slim profile achieved by one-piece extruded diffuser, it guarantees 100% no water intrusion
- Dual Lumen Output in one luminaire: 2 steps selectable lumen which equivalent to two lamps (HO) and single lamp version (LO); enhancing inventory flexibility
- Cutting edge tool-less wiring and fast installation by sliding mounting clips
- Additional Live (L1, L2, E, N) not only allows for connection of emergency kit and PIR sensor; but also enable for forming more than 1 group master/slave in PIR sensor module (LA11155), which operate independently in each group
- DC input compatible
- Through wiring connection possible
- Thanks for wide beam distribution, it delivers high uniformity of light and make perfect for application such as car park
- IP66 and IK08 rated
- Theft Proof mounting accessory also available (LA10195)
- Flicker free avoid stroboscopic effect in industrial premises
- D-mark  with limited surface temperature in compliance of EN60598-2-24
- Operating temperature from -30°C to +50°C



Applications

- Car parks
- Garages
- Under canopy
- Subways
- Workshops
- Warehouses and similar applications

Plug-and Play : Connect up to

- 73 units for FOB75000v0
- 37 units for FOB75100v0-ds (at High output)
- 24 units for FOB75200v0-ds (at High output)

* Based on using 1.5mm² wire

MEGAMAN® TARON

FOB75000v0



IP66 IK08 $\lambda >0.9$ Class II Flicker Free

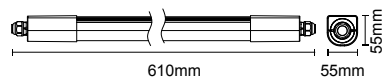

FOB75100v0-ds



IP66 IK08 $\lambda >0.9$ Class II Flicker Free

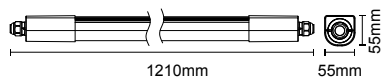

FOB75200v0-ds



IP66 IK08 $\lambda >0.9$ Class II Flicker Free

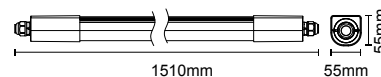

220-240V

Silver (SV16)

Model No.	Wattage (W)	Luminous Flux (lm)	Lm/W	Beam Angle	Colour Temp.	CRI	Dimension (mm)	Rated Life at L80 B10 at Ta25°C (hrs)	Materials
FOB75000v0	17	2000	118	120/160° (Lambertian)	4000K	≥80	W55 x L610 x H55	50000	Polycarbonate
FOB75100v0-ds	17/33	2100/4000	124/121	120/160° (Lambertian)	4000K	≥80	W55 x L1210 x H55	50000	Polycarbonate
FOB75200v0-ds	33/50	4000/6000	121/120	120/160° (Lambertian)	4000K	≥80	W55 x L1510 x H55	50000	Polycarbonate

FOB75000v0 (17W)

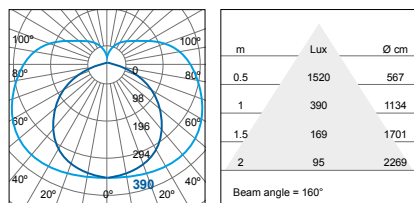

FOB75100v0-ds (17W)

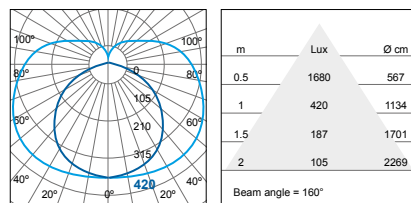

FOB75200v0-ds (33W)

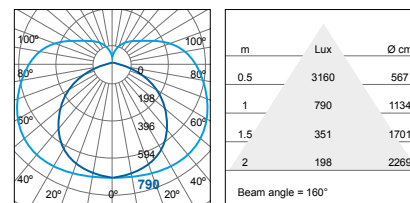

FOB75100v0-ds (33W)

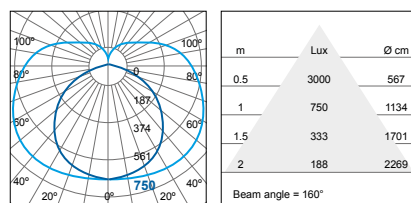

FOB75200v0-ds (50W)

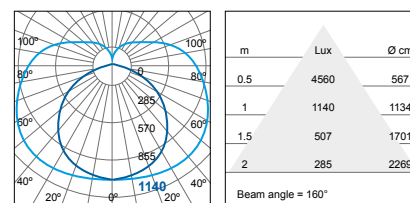

LA11155
PIR sensor module
L130 x W65 x H50mm



LA11156
Emergency module
L214 x W57 X H83mm

Permanent Live Option

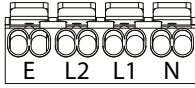

L1: Switched Live
 L2: Permanent Live

4-wire connection, allows unswitched live supply to the luminaire or appliances (i.e. CCTV, security alarm system, smoke detector, etc.) when the switch is off



PIR Sensor

Application with PIR sensor module (model no.: LA11155)

When the switch is off, the PIR sensor modules in Group 1 and Group 2 are still connected. This allows the two PIR modules to work independently switching each group separately as they are activated. This allows 'corridor functionality', for example in an underground car park.

LA11155

TARON



PIR Sensor

TARON with PIR sensor module, Master - Slave

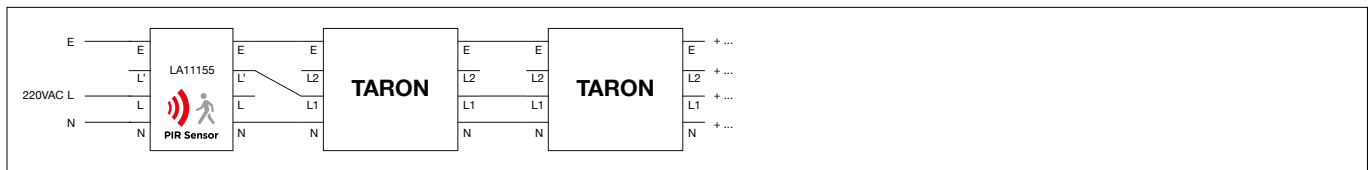

TARON with PIR sensor module, Master - Slave - Master

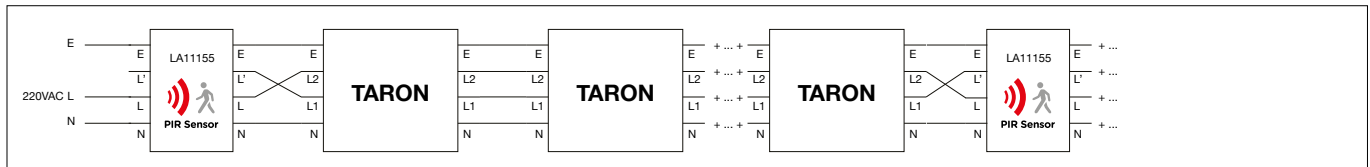

Application with Emergency Module (Model no. : LA11156)

Non-maintained emergency luminaires stay connected and charge on the permanent live, while the general lighting can work as usual on the switched circuit. In the event of power failure, the emergency units light up on their internal batteries.

TARON with Emergency module

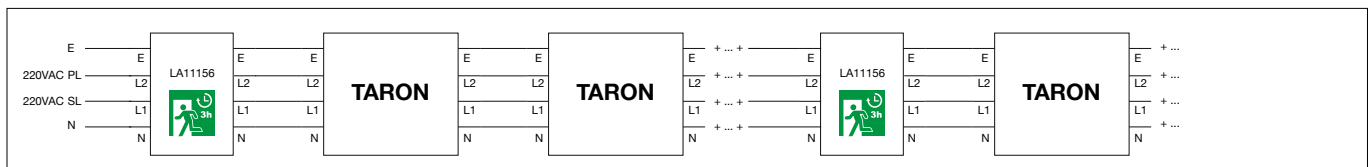

TARON with PIR sensor module and Emergency module with Permanent live control only, especially for Tunnel or Underground car park application

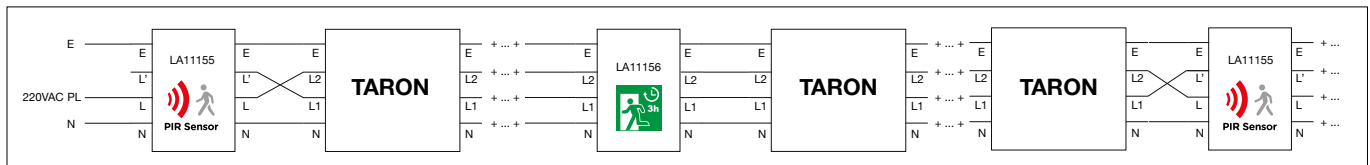

MEGAMAN® TARON



Dual Lumen Output

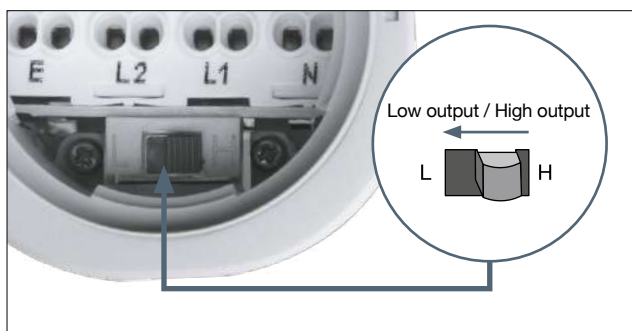

Tool-less wiring

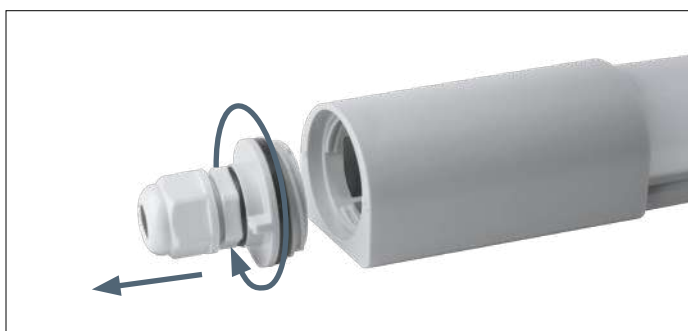

Suspension accessory
(Hook included; suspension wire excluded)

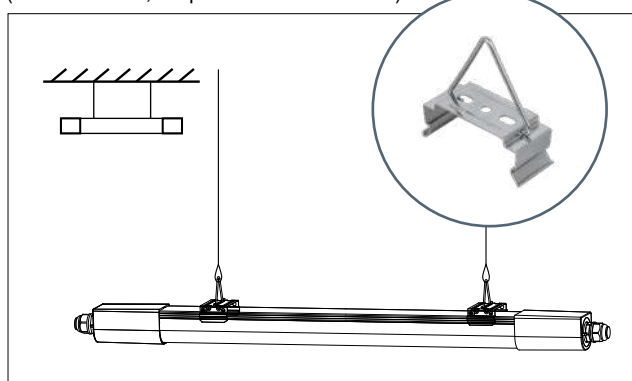

Theft Proof mounting accessory
(optional) – LA10195

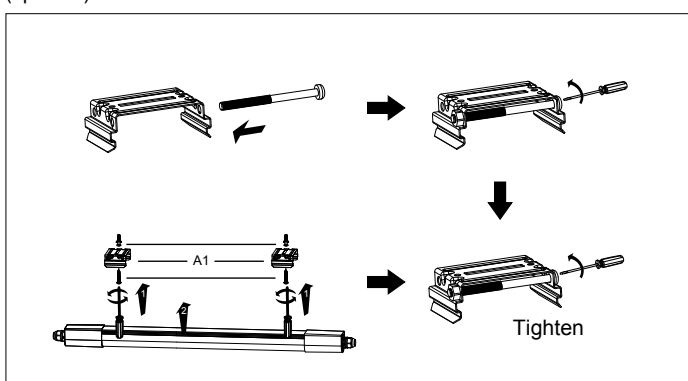

Chemical Resistance

Chemical Agents	Polycarbonate	Strainless Steel
Acetic acid 10%	+	+
Acetone	-	+
Alcoholic beverages	+	+
Aluminium sulphate	+	o
Ammonia 5%	-	+
Aniline	-	+
Arsenic acid 20%	+	+
Benzene	-	o
Bencylic alcohol	-	o
Bromine	-	-
Calcium Chloride	+	o
Calcium nitrate	+	o
Carbon tetrachloride	-	o
Carbonic acid	-	+
Caustic potash 5%	-	o
Cement	+	o
Hydrochloric acid 1-5%	+	-
Chlorine liquids (vapours)	-	o
Chloroform	-	+
Chromic acid	o	o
Citric acid 20%	+	o
Copper sulphate	+	o
Diesel-naphta oil	o	+
Ethyl alcohol 30%	+	+
Ethyl chloride	-	+
Ethyl ether	-	o
food oils and fats	-	+
formic acid 10%	+	o
Glycerine	+	+

Chemical Agents	Polycarbonate	Strainless Steel
Hexane	+	+
Iodine	-	-
Iron chloride	+	-
Isopropylic alcohol	o	o
Lubricating oil	+	+
Magnesium sulphate	+	+
Methanol	-	+
Mineral oils	+	+
Nitric acid 20%	o	+
Oxygen	+	+
Ozone	+	o
Perchloric acid 10%	+	-
Petrol	-	+
Phenol	-	o
Pothassium bromide	+	o
Pothassium nitrate	+	o
Pothassium permanganate	+	o
Sea climate	+	o
Silicon oils	+	+
Soda bleach 15%	-	o
Sodium chloride	+	o
Sodium hydroxide 5%	-	o
Sodium sulphate	+	o
Sugar	+	+
Sulphur	+	o
Sulphuric acid 30%	+	-
Toluene	-	+
Trichloroethylene	-	o
Zinc sulphate	+	o

+	Resistant
o	Relatively resistant
-	Non-resistant

Indoor Lighting / Integrated Waterproof LED Batten

MEGAMAN® HAGON 2



NEW

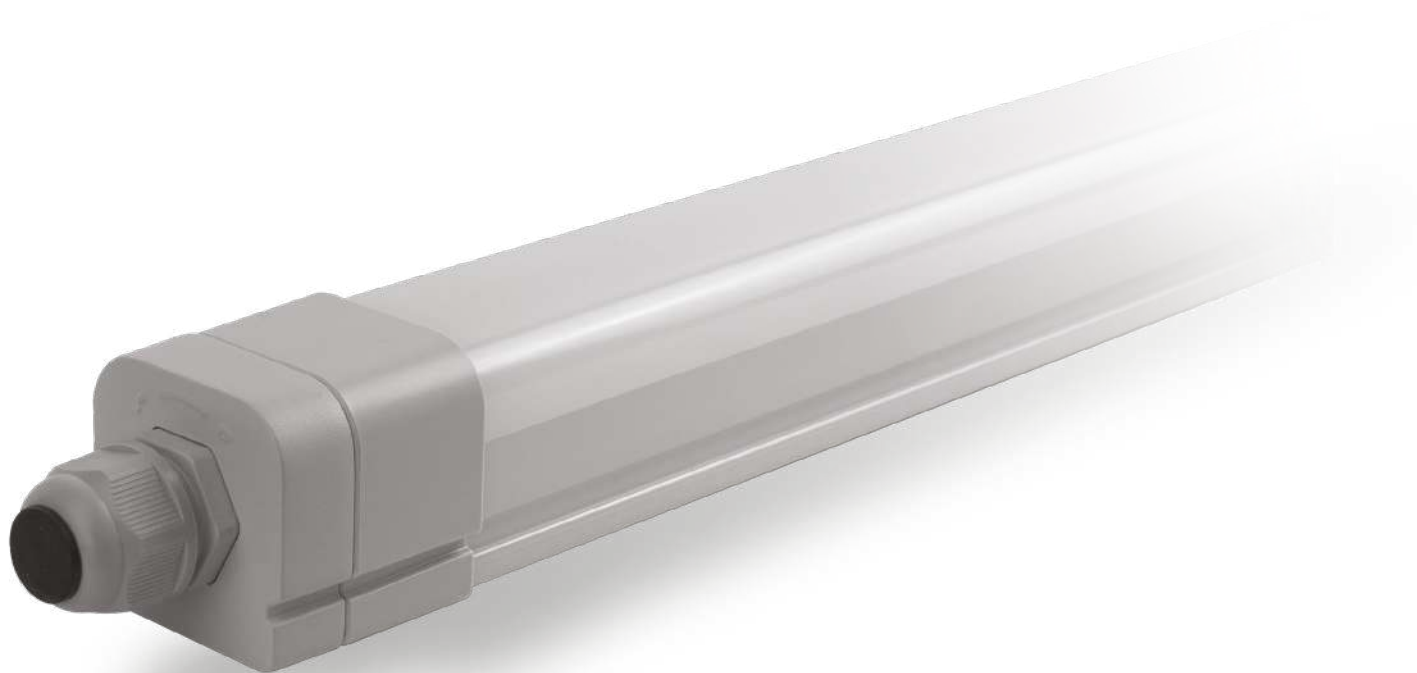

MEGAMAN® HAGON 2

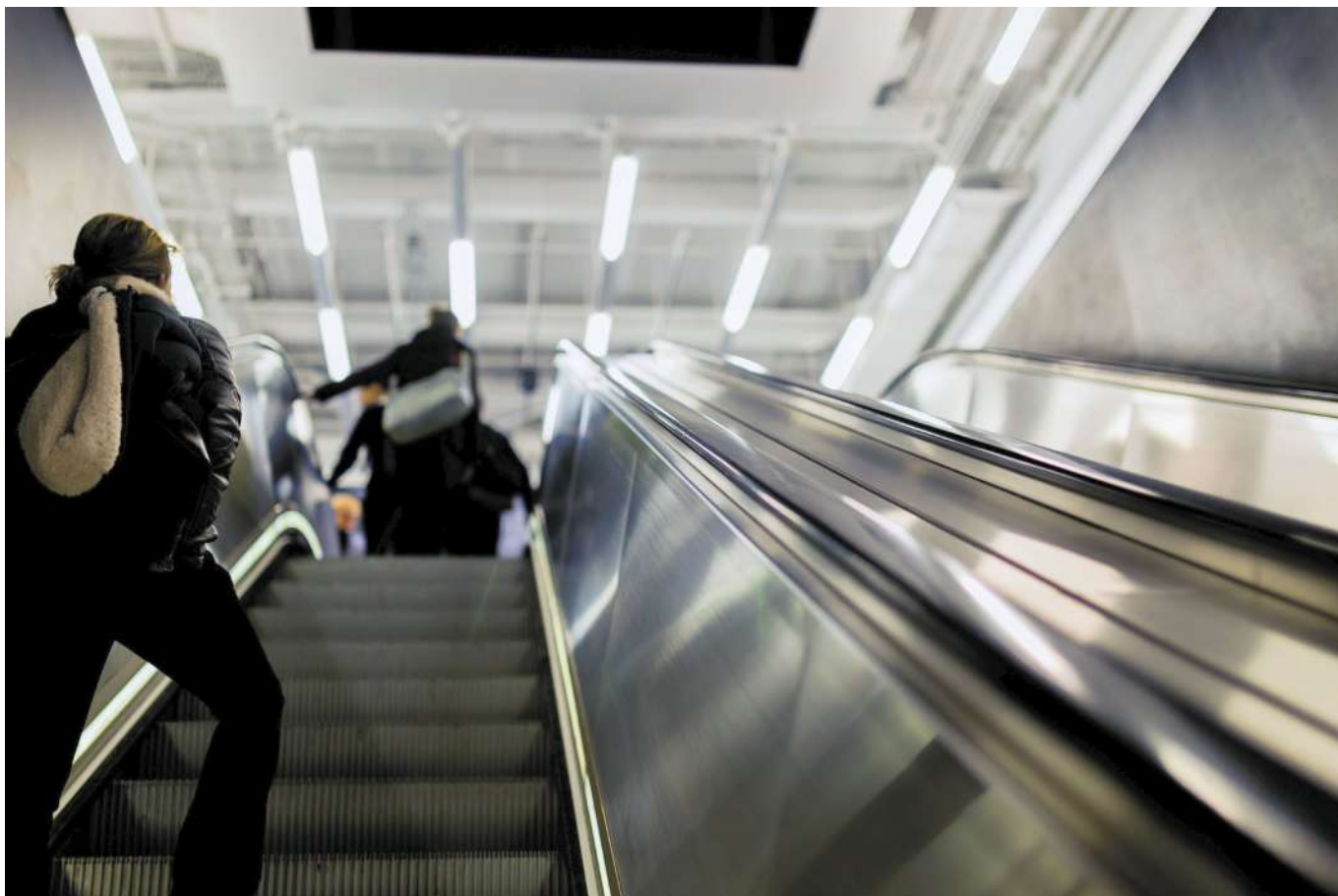

MEGAMAN® HAGON 2

Integrated Waterproof LED Batten

Features

- Compact and slim profile achieved by one-piece extruded diffuser, it guarantees 100% no water intrusion
- Dual Lumen Output in one luminaires (1.2m and 1.5m): 2 steps selectable lumen which equivalent to two lamps (HO) and single lamp version (LO); enhancing inventory flexibility
- Compatible with attachable PIR Sensor (LA11155), allowing to form a master and slave in lighting system
- Energy saving with efficacy up to 140lm/W
- Tool-less installation (loop-in/ loop-out with push-in terminal)
- IP66 and IK08 rated
- Compatible with 4 x 2.5mm² and 6 x 2.5mm² cable with M20 cable gland for ON/OFF and DALI version respectively
- Flicker free
- Theft proof mounting accessory is available

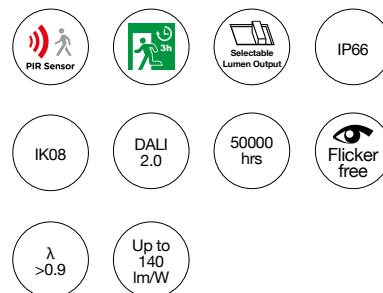

Applications

- Car Park
- Warehouse
- Workshops
- Underground areas

Theft-proof
Stainless steel mounting clips

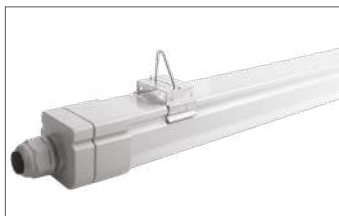

MEGAMAN® HAGON 2

FOB8000v0-ds
FOB8000v0-da

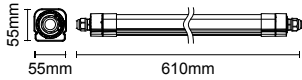
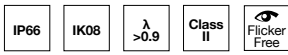

FOB80100v0-ds
FOB80100v0-da

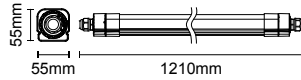
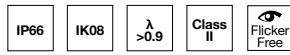

FOB80200v0-ds
FOB80200v2-ds
FOB80200v0-da
FOB80200v2-da

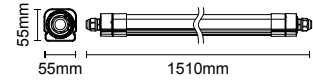
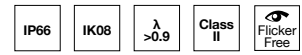

220-240V 120lm/w

Grey (SV16)

ON/OFF

Model No.	Wattage (W)	Lumen (lm)	Luminous Efficacy (lm/W)	Beam Angle	Dimension (mm)	Colour Temp (CRI)	Rated Life at L80 B10 at Ta25°C (hrs)	Materials
FOB8000v0-ds	9/17	1100/2000	122/118	120/160° (Lambertian)	L610 x W55 x H55	4000K [≥80]	50000	Polycarbonate
FOB80100v0-ds	17/33	2000/4000	118/121	120/160° (Lambertian)	L1210 x W55 x H55	4000K [≥80]	50000	Polycarbonate
FOB80200v0-ds	33/50	4000/6000	121/120	120/160° (Lambertian)	L1510 x W55 x H55	4000K [≥80]	50000	Polycarbonate
FOB80200v2-ds	50/70	6000/8400	120/120	120/160° (Lambertian)	L1510 x W55 x H55	4000K [≥80]	50000	Polycarbonate

DALI 2.0

Model No.	Wattage (W)	Lumen (lm)	Luminous Efficacy (lm/W)	Beam Angle	Dimension (mm)	Colour Temp (CRI)	Rated Life at L80 B10 at Ta25°C (hrs)	Materials
FOB8000v0-da	17	2400	141	120/160° (Lambertian)	L610 x W55 x H55	4000K [≥80]	50000	Polycarbonate
FOB80100v0-da	33	4600	140	120/160° (Lambertian)	L1210 x W55 x H55	4000K [≥80]	50000	Polycarbonate
FOB80200v0-da	50	7000	140	120/160° (Lambertian)	L1510 x W55 x H55	4000K [≥80]	50000	Polycarbonate
FOB80200v2-da	70	10000	143	120/160° (Lambertian)	L1510 x W55 x H55	4000K [≥80]	50000	Polycarbonate

Accessory



LA11155
Motion Sensor Module



LA11156
3H Emergency Kit

MEGAMAN® HAGON 2

FOB80000v1-ds
FOB80000v1-da



IP66 IK08 $\lambda >0.9$ Class II Flicker Free

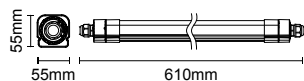

FOB80100v1-ds
FOB80100v1-da



IP66 IK08 $\lambda >0.9$ Class II Flicker Free

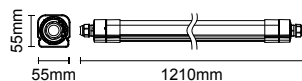

FOB80200v1-ds
FOB80200v3-ds
FOB80200v1-da
FOB80200v3-da



IP66 IK08 $\lambda >0.9$

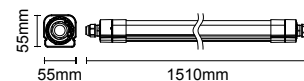

220-240V

140lm/w

Grey (SV16)

ON/OFF

Model No.	Wattage (W)	Lumen (lm)	Luminous Efficacy (lm/W)	Beam Angle	Dimension (mm)	Colour Temp (CRI)	Rated Life at L80 B10 at Ta25°C (hrs)	Materials
	9/17	1300/2400	144/141	120/160° (Lambertian)	L610 x W55 x H55	4000K [≥80]	50000	Polycarbonate
FOB80100v1-ds	17/33	2400/4600	141/139	120/160° (Lambertian)	L1210 x W55 x H55	4000K [≥80]	50000	Polycarbonate
FOB80200v1-ds	33/50	4600/7000	139/140	120/160° (Lambertian)	L1510 x W55 x H55	4000K [≥80]	50000	Polycarbonate
FOB80200v3-ds	50/70	7000/10000	140/143	120/160° (Lambertian)	L1510 x W55 x H55	4000K [≥80]	50000	Polycarbonate

DALI 2.0

Model No.	Wattage (W)	Lumen (lm)	Luminous Efficacy (lm/W)	Beam Angle	Dimension (mm)	Colour Temp (CRI)	Rated Life at L80 B10 at Ta25°C (hrs)	Materials
FOB80000v1-da	17	2400	141	120/160° (Lambertian)	L610 x W55 x H55	4000K [≥80]	50000	Polycarbonate
FOB80100v1-da	33	4600	140	120/160° (Lambertian)	L1210 x W55 x H55	4000K [≥80]	50000	Polycarbonate
FOB80200v1-da	50	7000	140	120/160° (Lambertian)	L1510 x W55 x H55	4000K [≥80]	50000	Polycarbonate
FOB80200v3-da	70	10000	143	120/160° (Lambertian)	L1510 x W55 x H55	4000K [≥80]	50000	Polycarbonate

Accessory



LA11155
Motion Sensor Module



LA11156
3H Emergency Kit

MEGAMAN® HAGON 2

HAGON 2 Photometric Data 120lm/W Version

FOB80000v0-ds (9W)

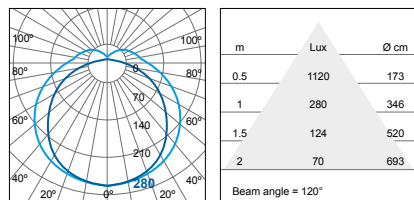

FOB80100v0-ds (17W)

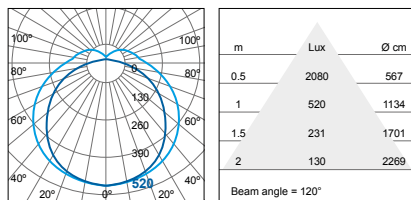

FOB80200v0-ds (33W)

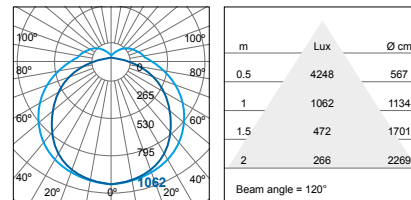

FOB80000v0-ds (17W)

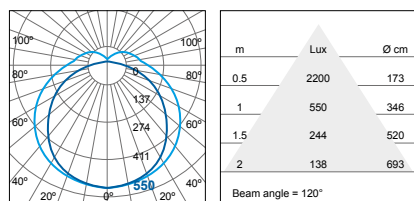

FOB80100v0-ds (33W)

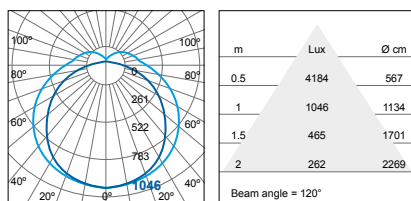

FOB80200v0-ds (50W)

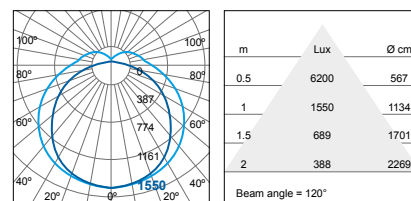

FOB80200v2-ds (50W)

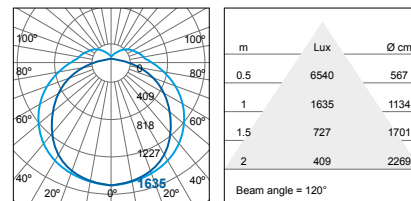

FOB80200v2-ds (70W)

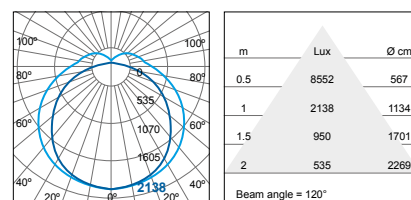

MEGAMAN® HAGON 2

HAGON 2 Photometric Data 140lm/W Version

FOB80000v1-ds (9W)

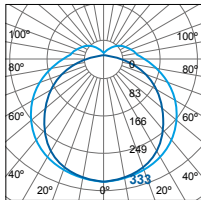

m	Lux	Ø cm
0.5	1332	173
1	333	346
1.5	148	520
2	83	693

Beam angle = 120°

FOB80100v1-ds (17W)

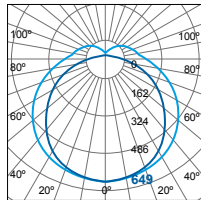

m	Lux	Ø cm
0.5	2596	567
1	649	1134
1.5	288	1701
2	162	2269

Beam angle = 120°

FOB80200v1-ds (33W)

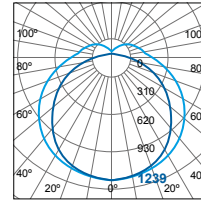

m	Lux	Ø cm
0.5	4956	567
1	1239	1134
1.5	551	1701
2	310	2269

Beam angle = 120°

FOB80000v1-ds (17W)

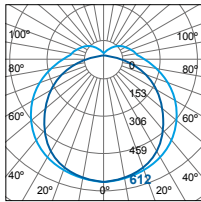

m	Lux	Ø cm
0.5	2448	173
1	612	346
1.5	272	520
2	153	693

Beam angle = 120°

FOB80100v1-ds (33W)

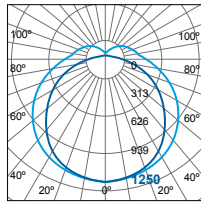

m	Lux	Ø cm
0.5	5000	567
1	1250	1134
1.5	556	1701
2	313	2269

Beam angle = 120°

FOB80200v1-ds (50W)

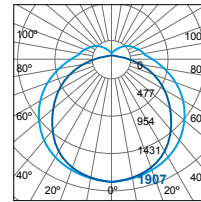

m	Lux	Ø cm
0.5	7628	567
1	1907	1134
1.5	848	1701
2	477	2269

Beam angle = 120°

FOB80200v3-ds (50W)

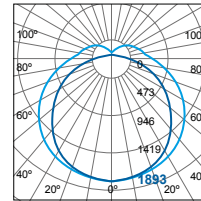

m	Lux	Ø cm
0.5	7572	567
1	1893	1134
1.5	841	1701
2	473	2269

Beam angle = 120°

FOB80200v3-ds (70W)

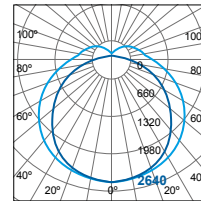

m	Lux	Ø cm
0.5	10560	567
1	2640	1134
1.5	1173	1701
2	660	2269

Beam angle = 120°

MEGAMAN® DINO 2



MEGAMAN® DINO 2

Integrated Damp Proof LED Batten

To continue the successful story of our existing batten series, MEGAMAN® DINO 2 is designed to offer an ideal alternative to T5 and T8 waterproof battens for outdoor and indoor applications. It comes with sliding stainless steel clips for easy and flexible installation. The permanent live option of MEGAMAN® DINO 2 allows unswitched live supply to the luminaire or appliances (i.e. sensors, emergency lighting, CCTV, security alarm system, smoke detector and so on.) when the switch is off.

Both PIR sensor and emergency lighting options are available. MEGAMAN® DINO 2 with PIR version comes on when it senses movement of the human body. The MEGAMAN® DINO 2 emergency lighting module provides enough light for escape using its internal batteries in the event of power failure.

Features

- One piece structural design in plastic extrusion profile with IP66 protection, MEGAMAN® DINO 2 offers intrinsically superior protection against water and dust than conventional T5 and T8 outdoor waterproof battens
- Designed with a tough polycarbonate body with IK08 rating for vandal resistance
- Easy and flexible installation through sliding stainless steel clips. Enabling use of existing mounting holes to replace conventional light fittings
- High lumen output of up to 6500lm
- Cable entries and through wiring allow for linear series connection
- Compatible with attachable PIR sensor, allowing to form a master and slave light system

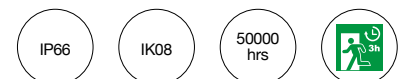

Applications

- Car parks
- Warehouses
- Workshops
- Underground areas

Max. number of connections

- 65 units for FOB61400v0-pl
- 59 units for FOB61500v0-pl
- 34 units for FOB61500v1-pl
- 39 units for FOB61600v0-pl
- 23 units for FOB61600v1-pl

* Based on using 1.5mm² wire

* Number of looping up to 6A Max.

Indoor Lighting / Damp Proof Batten

MEGAMAN® DINO 2

FOB61400v0-pl



IP66 IK08 $\lambda >0.9$ Class II



FOB61500v0-pl / FOB61500v1-pl



IP66 IK08 $\lambda >0.9$ Class II



FOB61600v0-pl / FOB61600v0-pl



IP66 IK08 $\lambda >0.9$ Class II

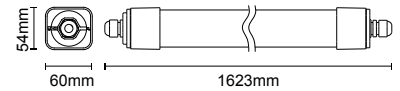

220-240V

Silver (SV16)

Permanent Live Option | Opal Prismatic Diffuser Options

Model No.	Wattage (W)	Luminous Flux (lm)	Luminous Efficacy (lm/W)	Beam Angle (°)	Dimension (mm)	Colour Temp. [CRI]	Rated Life at L80 B10 at Ta25°C (hrs)	Power Factor (λ)	Materials
FOB61400v0-pl	19	1750 [3000K] 1800 [4000K]	92 [3000K] 95 [4000K]	160	L723 x W60 x H54	3000K / 4000K [\geq Ra80]	50000	>0.9	Polycarbonate with opal prismatic diffuser
FOB61500v0-pl	21	2250 [3000K] 2350 [4000K]	107 [3000K] 112 [4000K]	160	L1323 x W60 x H54	3000K / 4000K [\geq Ra80]	50000	>0.9	Polycarbonate with opal prismatic diffuser
FOB61500v1-pl	36	4150 [3000K] 4300 [4000K]	115 [3000K] 119 [4000K]	160	L1323 x W60 x H54	3000K / 4000K [\geq Ra80]	50000	>0.9	Polycarbonate with opal prismatic diffuser
FOB61600v0-pl	32	3500 [3000K] 3600 [4000K]	109 [3000K] 113 [4000K]	160	L1623 x W60 x H54	3000K / 4000K [\geq Ra80]	50000	>0.9	Polycarbonate with opal prismatic diffuser
FOB61600v1-pl	53	6300 [3000K] 6500 [4000K]	119 [3000K] 123 [4000K]	160	L1623 x W60 x H54	3000K / 4000K [\geq Ra80]	50000	>0.9	Polycarbonate with opal prismatic diffuser

Accessory



LA11155
PIR sensor module
L130 x W65 x H50mm



LA11156
Emergency module
L214 x W57 X H83mm



LA8066
Cover for concealing
two end cable glands
and power cable



LA8021
Hook for suspension



LA8032
Theft proof bracket

MEGAMAN® DINO 2

Permanent Live Option

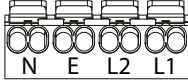

L1: Permanent Live
L2: Switched Live

4-wire connection, allows unswitched live supply to the luminaire or appliances (i.e. CCTV, security alarm system, smoke detector, etc.) when the switch is off



PIR Sensor

Application with PIR sensor module (model no.: LA11155)
When the switch is off, the PIR sensor modules in Group 1 and Group 2 are still connected. This allows the two PIR modules to work independently switching each group separately as they are activated. This allows 'corridor functionality', for example in an underground car park.

LA11155

DINO 2



PIR Sensor

DINO 2 with PIR module, Master - Slave

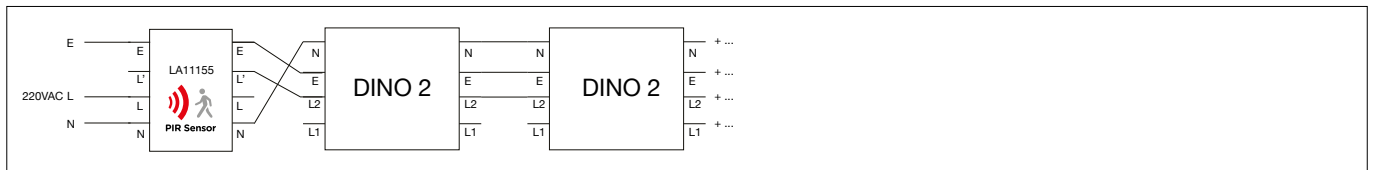

DINO 2 with PIR module, Master - Slave - Master

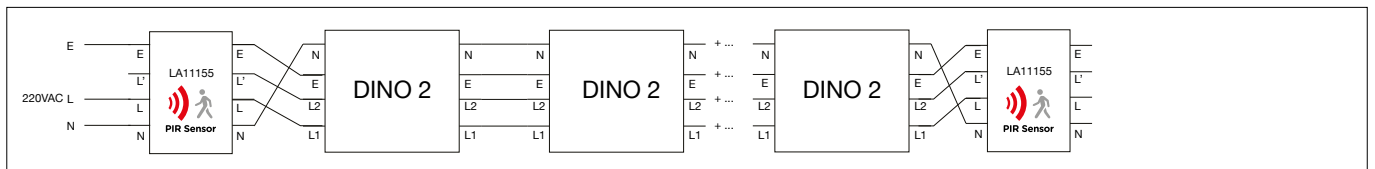

Application with Emergency Module (Model no. : LA11156)

Non-maintained emergency luminaires stay connected and charge on the permanent live, while the general lighting can work as usual on the switched circuit. In the event of power failure, the emergency units light up on their internal batteries.

DINO 2 with Emergency module

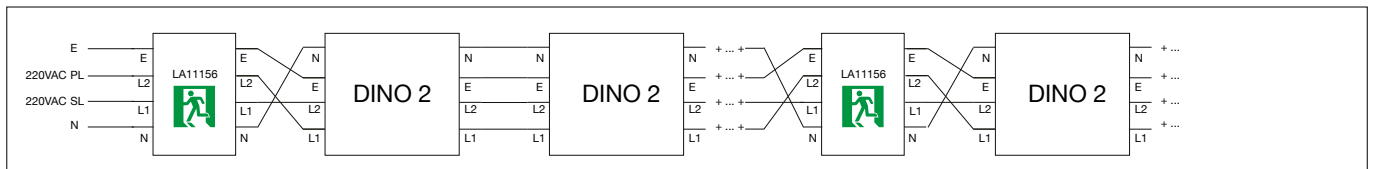

DINO 2 with PIR sensor module and Emergency module with Permanent live control only, especially for Tunnel or Underground car park application.

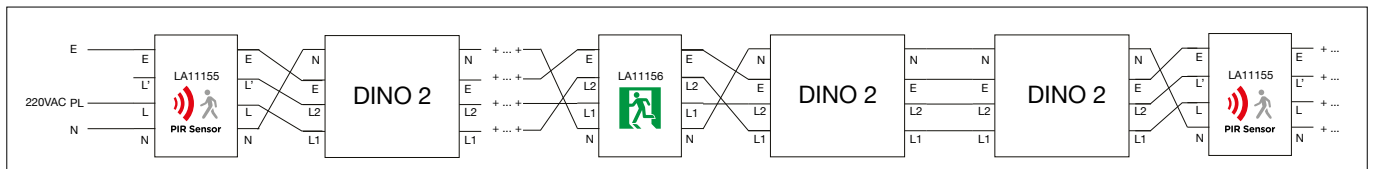

DINO 2 Photometric Data

FOB61400v0-pl

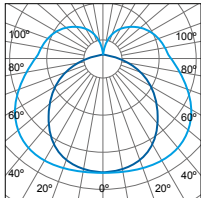

m	Lux	Ø cm
0.5	1320	1320
1	330	660
1.5	147	440
2	83	330

Beam angle = 160°

FOB61500v0-pl

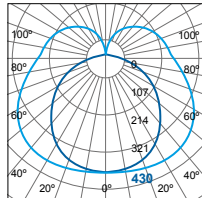

m	Lux	Ø cm
0.5	1720	1720
1	430	860
1.5	191	573
2	80	430

Beam angle = 160°

FOB61500v1-pl

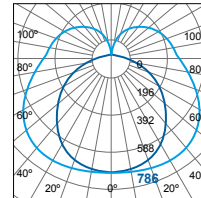

m	Lux	Ø cm
0.5	3144	3144
1	786	1572
1.5	349	1048
2	197	786

Beam angle = 160°

FOB61600v0-pl

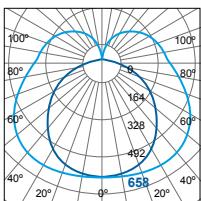

m	Lux	Ø cm
0.5	2632	2632
1	658	1316
1.5	292	877
2	165	658

Beam angle = 160°

FOB61600v1-pl

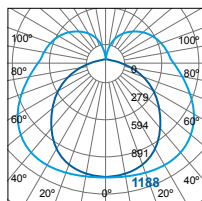

m	Lux	Ø cm
0.5	4752	4752
1	1188	2376
1.5	528	1584
2	297	1188

Beam angle = 160°

Chemical Resistance

Chemical Agents	Polycarbonate	Stainless Steel
Acetic acid 10%	+	+
Acetone	-	+
Alcoholic beverages	+	+
Aluminium sulphate	+	o
Ammonia 5%	-	+
Aniline	-	+
Arsenic acid 20%	+	+
Benzene	-	o
Bencylic alcohol	-	o
Bromine	-	-
Calcium Chloride	+	o
Calcium nitrate	+	o
Carbon tetrachloride	-	o
Carbonic acid	-	+
Caustic potash 5%	-	o
Cement	+	o
Hydrochloric acid 1-5%	+	-
Chlorine liquids (vapours)	-	o
Chloroform	-	+
Chromic acid	o	o
Citric acid 20%	+	o
Copper sulphate	+	o
Diesel-naphta oil	o	+
Ethyl alcohol 30%	+	+
Ethyl chloride	-	+
Ethyl ether	-	o
food oils and fats	-	+
formic acid 10%	+	o
Glycerine	+	+

Chemical Agents	Polycarbonate	Stainless Steel
Hexane	+	+
Iodine	-	-
Iron chloride	+	-
Isopropyl alcohol	o	o
Lubricating oil	+	+
Magnesium sulphate	+	+
Methanol	-	+
Mineral oils	+	+
Nitric acid 20%	o	+
Oxygen	+	+
Ozone	+	o
Perchloric acid 10%	+	-
Petrol	-	+
Phenol	-	o
Potassium bromide	+	o
Potassium nitrate	+	o
Potassium permanganate	+	o
Sea climate	+	o
Silicon oils	+	+
Soda bleach 15%	-	o
Sodium chloride	+	o
Sodium hydroxide 5%	-	o
Sodium sulphate	+	o
Sugar	+	+
Sulphur	+	o
Sulphuric acid 30%	+	-
Toluene	-	+
Trichloroethylene	-	o
Zinc sulphate	+	o

+	Resistant
o	Relatively resistant
-	Non-resistant

MEGAMAN® DINO 2 FARM



Indoor Lighting / Damp Proof Batten

MEGAMAN® DINO 2 FARM



MEGAMAN® DINO 2 FARM

Integrated Damp Proof LED Batten

LEDs need special protection from the aggressive chemical atmospheres in agricultural applications. MEGAMAN® DINO 2 FARM is designed to solve the problem in challenging areas such as animal husbandry. The chemical resistant housing materials, and the IP66 and IK04 ratings for ingress protection with high impact resistance enable it to withstand harsh farm environments. Furthermore, the tool-less wiring and fast fixing stainless steel mounting clips enable easy installation.

Features

- Special version of the popular DINO 2 waterproof batten for hostile agricultural environments
- Chemical resistant housing materials designed to withstand harsh farm locations
- Ideal for use in intensive animal husbandry such as pigsties and cowsheds where high levels of resistance to aggressive ammonia-containing gases is essential
- Airtight construction offers extra protection to the luminaire with the blockage of outside gas
- Durable and robust, sealed to IP66 for ingress protection with high impact resistance of IK04 Self-contained integrated LED units – flexible for installation and inventory management
- Excellent lighting performance of up to 6500lm
- Energy saving with efficacies up to 123lm/W
- Long Lifetime of 50,000 hrs L80, B10 for low maintenance and further cost saving
- Tool-less wiring and fast-fixing stainless steel mounting clips for easy installation
- DLG (Deutsche Landwirtschafts-Gesellschaft – German Agricultural Society) certified with ammonia resistant and is applicable for high pressure cleaning with a minimum distance of 15cm



Applications

- Livestock husbandry (pigsties, cowsheds and poultry farm)



Max. number of connections

- 34 units for FOB70800v1-pl
- 23 units for FOB70900v1-pl

* Based on using 1.5mm² wire
* Number of looping up to 6A Max.

MEGAMAN® DINO 2 FARM

FOB70800v1-pl



IP66 IK08 $\lambda >0.9$ Class II

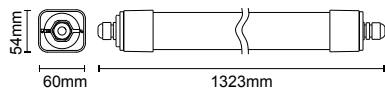

FOB70900v1-pl



IP66 IK08 $\lambda >0.9$ Class II

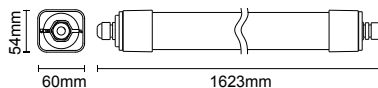

220-240V

Silver (SV16)

Model No.	Wattage (W)	Luminous Flux (lm)	Luminous Efficacy (lm/W)	Beam Angle (°)	Dimension (mm)	Colour Temp. [CRI]	Rated life at L80 B10 at Ta25°C (hrs)	Power Factor (λ)	Material
FOB70800v1-pl	36	4150 [3000K] 4300 [4000K]	115 [3000K] 119 [4000K]	120	L1323 x W60 x H54	3000K / 4000K [\geq Ra80]	50000	>0.9	End cap made of polyamide with PMMA diffuser
FOB70900v1-pl	53	6300 [3000K] 6500 [4000K]	119 [3000K] 123 [4000K]	120	L1623 x W60 x H54	3000K / 4000K [\geq Ra80]	50000	>0.9	End cap made of polyamide with PMMA diffuser

FOB70800v1-pl

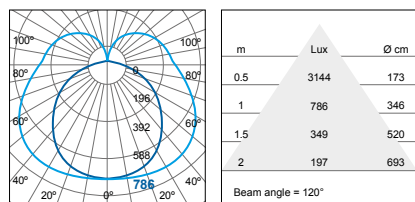

FOB70900v1-pl

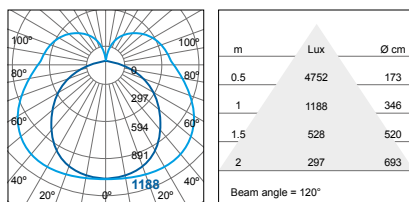

MEGAMAN® DINO 2 FARM

Chemical Resistance

Chemical Agents	Polycarbonate	PMMA	Stainless Steel	Chemical Agents	Polycarbonate	PMMA	Stainless Steel
Acetic acid 10%	+	+	+	Hexane	+	+	+
Acetone	-	-	+	Iodine	-	+	-
Alcoholic beverages	+	o	+	Iron chloride	+	+	-
Aluminium sulphate	+	+	o	Isopropyl alcohol	o	o	o
Ammonia 5%	-	+	+	Lubricating oil	+	+	+
Aniline	-	-	+	Magnesium sulphate	+	+	+
Arsenic acid 20%	+	+	+	Methanol	-	o	+
Benzene	-	-	o	Mineral oils	+	+	+
Bencylic alcohol	-	-	o	Nitric acid 20%	o	+	+
Bromine	-	-	-	Oxygen	+	+	+
Calcium Chloride	+	+	o	Ozone	+	+	o
Calcium nitrate	+	+	o	Perchloric acid 10%	+	+	-
Carbon tetrachloride	-	-	o	Petrol	-	+	+
Carbonic acid	-	-	+	Phenol	-	-	o
Caustic potash 5%	-	+	o	Potassium bromide	+	+	o
Cement	+	+	o	Potassium nitrate	+	+	o
Hydrochloric acid 1-5%	+	+	-	Potassium permanganate	+	+	o
Chlorine liquids (vapours)	-	-	o	Sea climate	+	+	o
Chloroform	-	-	+	Silicon oils	+	o	+
Chromic acid	o	o	o	Soda bleach 15%	-	+	o
Citric acid 20%	+	+	o	Sodium chloride	+	+	o
Copper sulphate	+	+	o	Sodium hydroxide 5%	-	+	o
Diesel-naphta oil	o	+	+	Sodium sulphate	+	+	o
Ethyl alcohol 30%	+	o	+	Sugar	+	+	+
Ethyl chloride	-	-	+	Sulphur	+	+	o
Ethyl ether	-	-	o	Sulphuric acid 30%	+	+	-
food oils and fats	-	+	+	Toluene	-	-	+
formic acid 10%	+	+	o	Trichloroethylene	-	-	o
Glycerine	+	+	+	Zinc sulphate	+	+	o

+	Resistant
o	Relatively resistant
-	Non-resistant

Indoor Lighting / Damp Proof Batten

MEGAMAN® ROCCO



Indoor Lighting / Damp Proof Batten
MEGAMAN® ROCCO



MEGAMAN® ROCCO

Traditional Waterproof LED Batten

MEGAMAN® ROCCO is a basic solution for general lighting that provide quality of light, substantial energy and maintenance saving. It is an ideal replacement for traditional waterproof batten with fluorescent lamps, with addition optional features of built in microwave sensor and 3 hour emergency kit to provide functional flexibility with a consistent outlook.

Features

- Plug & play sensor and emergency kit modular enhance the flexibility for inventory
- ON/OFF Traditional waterproof LED batten
- Capable with 3 x 1.5mm² -2.5mm² cable entry
- Durable water and vandal resistant construction with IP65 & IK10 rating
- 4 different lengths 600mm, 1200mm, 1500mm & 1800mm
- Flicker Free <3%
- Stainless steel mounting clips; fitted with UK Beza box mounting

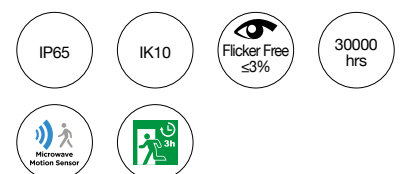

Applications

- Car parks
- Warehouses
- Stairwells
- Corridors
- Patios



Hook for suspension installation

MEGAMAN® ROCCO

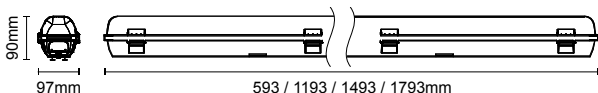
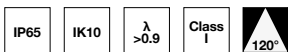

220-240V

Silver (SV12)

Single Tube Replacement

Model No. (Non-loopthrough)	Model No. (Loopthrough)	Wattage (W)	Luminous Flux (lm)	Luminous Efficacy (lm/W)	Dimension (mm)	Colour Temp (CRI)	Rated Life @ L70B50 @Ta25°C (hrs)	Materials
-----------------------------	-------------------------	-------------	--------------------	--------------------------	----------------	-------------------	-----------------------------------	-----------

Standard Version

FOB75600v0	FOB76900v0	12	1080	90	L593 x W94 x H90	4000K [Ra80]	30000	Polycarbonate
FOB75700v0	FOB77000v0	20	1800	90	L1193 x W94 x H90	4000K [Ra80]	30000	Polycarbonate
FOB75800v0	FOB77100v0	30	2700	90	L1493 x W94 x H90	4000K [Ra80]	30000	Polycarbonate
FOB75900v0	FOB77200v0	40	3600	90	L1793 x W94 x H90	4000K [Ra80]	30000	Polycarbonate

With Microwave Sensor



FOB75600v0-ms	FOB76900v0-ms	13	1080	83	L593 x W94 x H90	4000K [Ra80]	30000	Polycarbonate
FOB75700v0-ms	FOB77000v0-ms	21	1800	86	L1193 x W94 x H90	4000K [Ra80]	30000	Polycarbonate
FOB75800v0-ms	FOB77100v0-ms	31	2700	87	L1493 x W94 x H90	4000K [Ra80]	30000	Polycarbonate
FOB75900v0-ms	FOB77200v0-ms	41	3600	88	L1793 x W94 x H90	4000K [Ra80]	30000	Polycarbonate

With Emergency



FOB75700v0-em	FOB77000v0-em	22	1800	82	L1193 x W94 x H90	4000K [Ra80]	30000	Polycarbonate
FOB75800v0-em	FOB77100v0-em	32	2700	84	L1493 x W94 x H90	4000K [Ra80]	30000	Polycarbonate
FOB75900v0-em	FOB77200v0-em	42	3600	86	L1793 x W94 x H90	4000K [Ra80]	30000	Polycarbonate

With Microwave Sensor and Emergency



FOB75700v0-em/ms	FOB77000v0-em/ms	25	1800	72	L1193 x W94 x H90	4000K [Ra80]	30000	Polycarbonate
FOB75800v0-em/ms	FOB77100v0-em/ms	35	2700	77	L1493 x W94 x H90	4000K [Ra80]	30000	Polycarbonate
FOB75900v0-em/ms	FOB77200v0-em/ms	45	3600	80	L1793 x W94 x H90	4000K [Ra80]	30000	Polycarbonate

FOB75600v0
FOB75700v0
FOB75800v0
FOB75900v0

FOB76900v0
FOB77000v0
FOB77100v0
FOB77200v0



FOB75600v0-ms
FOB75700v0-ms
FOB75800v0-ms
FOB75900v0-ms

FOB76900v0-ms
FOB77000v0-ms
FOB77100v0-ms
FOB77200v0-ms



FOB75700v0-em
FOB75800v0-em
FOB75900v0-em

FOB77000v0-em
FOB77100v0-em
FOB77200v0-em



FOB75700v0-em/ms
FOB75800v0-em/ms
FOB75900v0-em/ms

FOB77000v0-em/ms
FOB77100v0-em/ms
FOB77200v0-em/ms



** Operation temperature from -30°C to +45°C; White models emergency modular is 0°C to +35°C

Indoor Lighting / Damp Proof Batten

MEGAMAN® ROCCO

FOB75600v1 FOB76900v1
 FOB75700v1 FOB77000v1
 FOB75800v1 FOB77100v1
 FOB75900v1 FOB77200v1



FOB75600v1-ms
 FOB75700v1-ms
 FOB75800v1-ms
 FOB75900v1-ms

FOB76900v1-ms
 FOB77000v1-ms
 FOB77100v1-ms
 FOB77200v1-ms



FOB75700v1-em
 FOB75800v1-em
 FOB75900v1-em

FOB77000v1-em
 FOB77100v1-em
 FOB77200v1-em



FOB75700v1-em/ms
 FOB75800v1-em/ms
 FOB75900v1-em/ms

FOB77000v1-em/ms
 FOB77100v1-em/ms
 FOB77200v1-em/ms



IP65 IK10 $\lambda > 0.9$ Class I 120°

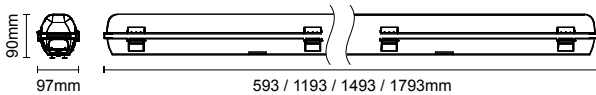

220-240V

Silver (SV12)

Double Tube Replacement

Model No. (Non-loopthrough)	Model No. (Loopthrough)	Wattage (W)	Luminous Flux (lm)	Luminous Efficacy (lm/W)	Dimension (mm)	Colour Temp (CRI)	Rated Life @ L70B50 @Ta25°C (hrs)	Materials
Standard Version								
FOB75600v1	FOB76900v1	20	1800	90	L593 x W94 x H90	4000K [Ra80]	30000	Polycarbonate
FOB75700v1	FOB77000v1	40	3600	90	L1193 x W94 x H90	4000K [Ra80]	30000	Polycarbonate
FOB75800v1	FOB77100v1	60	5400	90	L1493 x W94 x H90	4000K [Ra80]	30000	Polycarbonate
FOB75900v1	FOB77200v1	80	7200	90	L1793 x W94 x H90	4000K [Ra80]	30000	Polycarbonate
With Microwave Sensor								
FOB75600v1-ms	FOB76900v1-ms	21	1800	86	L593 x W94 x H90	4000K [Ra80]	30000	Polycarbonate
FOB75700v1-ms	FOB77000v1-ms	41	3600	88	L1193 x W94 x H90	4000K [Ra80]	30000	Polycarbonate
FOB75800v1-ms	FOB77100v1-ms	61	5400	89	L1493 x W94 x H90	4000K [Ra80]	30000	Polycarbonate
FOB75900v1-ms	FOB77200v1-ms	81	7200	89	L1793 x W94 x H90	4000K [Ra80]	30000	Polycarbonate
With Emergency								
FOB75700v1-em	FOB77000v1-em	42	3600	86	L1193 x W94 x H90	4000K [Ra80]	30000	Polycarbonate
FOB75800v1-em	FOB77100v1-em	64	5400	84	L1493 x W94 x H90	4000K [Ra80]	30000	Polycarbonate
FOB75900v1-em	FOB77200v1-em	84	7200	86	L1793 x W94 x H90	4000K [Ra80]	30000	Polycarbonate
With Microwave Sensor and Emergency								
FOB75700v1-em/ms	FOB77000v1-em/ms	45	3600	80	L1193 x W94 x H90	4000K [Ra80]	30000	Polycarbonate
FOB75800v1-em/ms	FOB77100v1-em/ms	65	5400	83	L1493 x W94 x H90	4000K [Ra80]	30000	Polycarbonate
FOB75900v1-em/ms	FOB77200v1-em/ms	85	7200	85	L1793 x W94 x H90	4000K [Ra80]	30000	Polycarbonate

** Operation temperature from -30°C to +45°C; White models emergency modular is 0°C to +35°C

MEGAMAN® ROCCA





MEGAMAN® ROCCA

Traditional Waterproof LED Batten

MEGAMAN® ROCCA is basic solution for general lighting that provide quality of light, substantial energy and maintenance saving. It is an ideal replacement for traditional waterproof batten with fluorescent lamps, with additional optional features of built in microwave sensor and 3 hours emergency kit to provide functional flexibility with a consistent outlook.

Features

- Replacement for traditional waterproof batten
- Built in Microwave sensor and Emergency provide a consistent outlook with standard version
- Durable water and vandal resistant construction with IP65 and IK08 rating
- 4 different lengths 600mm, 1200mm, 1500mm and 1800mm
- Easy installation and Tool-less wiring
- Sensor and Emergency options available
- Durable corrosion free Nylon clips
- Capable to mount in UK Beza Box



Applications

- Car parks
- Warehouses
- Stairwells
- Corridors
- Patios



Hook for suspension installation

MEGAMAN® ROCCA

FOB78400v0
FOB78500v0



FOB78600v0

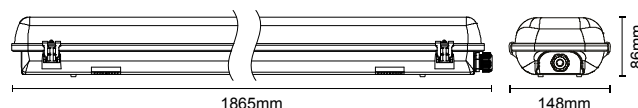
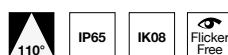
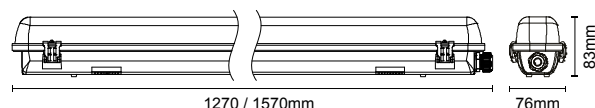
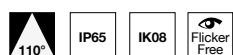

220-240V

Silver (SV12)

Single Tube Replacement

Model No.	Wattage (W)	Luminous Flux (lm)	Efficiency (lm/W)	Colour Temp. (CRI)	Beam Angle (°)	Dimension (mm)	Rated Life @L70B50 @ Ta25°C (hrs)	Materials
Standard Version								
FOB78400v0	20	2500	125	4000K [≥80]	110	L1270 x W76 x H83	40000	Anti-UV Plastic housing + PC diffuser
FOB78500v0	28	3600	129	4000K [≥80]	110	L1570 x W76 x H83	40000	Anti-UV Plastic housing + PC diffuser
FOB78600v0	34	4200	124	4000K [≥80]	110	L1865 x W148 x H86	40000	Anti-UV Plastic housing + PC diffuser
With Microwave Sensor								
FOB78400v0-ms	21	2500	119	4000K [≥80]	110	L1270 x W76 x H83	40000	Anti-UV Plastic housing + PC diffuser
FOB78500v0-ms	29	3600	124	4000K [≥80]	110	L1570 x W76 x H83	40000	Anti-UV Plastic housing + PC diffuser
FOB78600v0-ms	35	4200	120	4000K [≥80]	110	L1865 x W148 x H86	40000	Anti-UV Plastic housing + PC diffuser
With Emergency								
FOB78400v0-em	21	2500	119	4000K [≥80]	110	L1270 x W76 x H83	40000	Anti-UV Plastic housing + PC diffuser
FOB78500v0-em	29	3600	124	4000K [≥80]	110	L1570 x W76 x H83	40000	Anti-UV Plastic housing + PC diffuser
FOB78600v0-em	35	4200	120	4000K [≥80]	110	L1865 x W148 x H86	40000	Anti-UV Plastic housing + PC diffuser
With Microwave Sensor and Emergency								
FOB78400v0-em/ms	22	2500	114	4000K [≥80]	110	L1270 x W76 x H83	40000	Anti-UV Plastic housing + PC diffuser
FOB78500v0-em/ms	30	3600	120	4000K [≥80]	110	L1570 x W76 x H83	40000	Anti-UV Plastic housing + PC diffuser
FOB78600v0-em/ms	36	4200	117	4000K [≥80]	110	L1865 x W148 x H86	40000	Anti-UV Plastic housing + PC diffuser

** Operation temperature from -30°C to +45°C; White models emergency modular is 0°C to +35°C

Indoor Lighting / Waterproof Batten

MEGAMAN® ROCCA

FOB79200v0
FOB79300v0
FOB79400v0

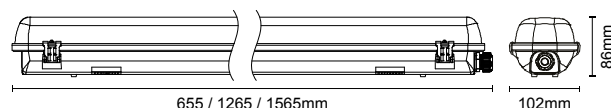
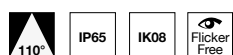

FOB78600v1

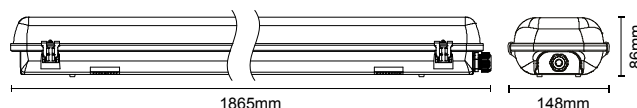
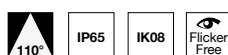

220-240V

Silver (SV12)

Double Tube Replacement

Model No.	Wattage (W)	Luminous Flux (lm)	Efficiency (lm/W)	Colour Temp. (CRI)	Beam Angle (°)	Dimension (mm)	Rated Life @L70B50 @ Ta25°C (hrs)	Materials
Standard Version								
FOB79200v0	30	3600	120	4000K [≥80]	110	L655 x W102 x H86	40000	Anti-UV Plastic housing + PC diffuser
FOB79300v0	40	4800	120	4000K [≥80]	110	L1265 x W102 x H86	40000	Anti-UV Plastic housing + PC diffuser
FOB79400v0	56	6800	121	4000K [≥80]	110	L1565 x W102 x H86	40000	Anti-UV Plastic housing + PC diffuser
FOB78600v1	70	9100	130	4000K [≥80]	110	L1865 x W148 x H86	40000	Anti-UV Plastic housing + PC diffuser
With Microwave Sensor								
FOB79200v0-ms	31	3600	116	4000K [≥80]	110	L655 x W102 x H86	40000	Anti-UV Plastic housing + PC diffuser
FOB79300v0-ms	41	4800	117	4000K [≥80]	110	L1265 x W102 x H86	40000	Anti-UV Plastic housing + PC diffuser
FOB79400v0-ms	57	6800	119	4000K [≥80]	110	L1565 x W102 x H86	40000	Anti-UV Plastic housing + PC diffuser
FOB78600v1-ms	71	9100	128	4000K [≥80]	110	L1865 x W148 x H86	40000	Anti-UV Plastic housing + PC diffuser
With Emergency								
FOB79200v0-em	31	3600	116	4000K [≥80]	110	L655 x W102 x H86	40000	Anti-UV Plastic housing + PC diffuser
FOB79300v0-em	41	4800	117	4000K [≥80]	110	L1265 x W102 x H86	40000	Anti-UV Plastic housing + PC diffuser
FOB79400v0-em	57	6800	119	4000K [≥80]	110	L1565 x W102 x H86	40000	Anti-UV Plastic housing + PC diffuser
FOB78600v1-em	71	9100	128	4000K [≥80]	110	L1865 x W148 x H86	40000	Anti-UV Plastic housing + PC diffuser
With Microwave Sensor and Emergency								
FOB79200v0-em/ms	32	3600	113	4000K [≥80]	110	L655 x W102 x H86	40000	Anti-UV Plastic housing + PC diffuser
FOB79300v0-em/ms	42	4800	114	4000K [≥80]	110	L1265 x W102 x H86	40000	Anti-UV Plastic housing + PC diffuser
FOB79400v0-em/ms	58	6800	117	4000K [≥80]	110	L1565 x W102 x H86	40000	Anti-UV Plastic housing + PC diffuser
FOB78600v1-em/ms	72	9100	126	4000K [≥80]	110	L1865 x W148 x H86	40000	Anti-UV Plastic housing + PC diffuser

** Operation temperature from -30°C to +45°C; White models emergency modular is 0°C to +35°C

** With Self-Test Function

* With manual Test Function

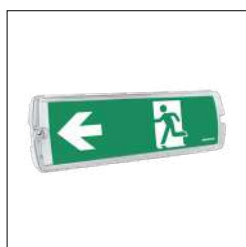

MEGAMAN® TEMPUS



MEGAMAN® TEMPUS

Emergency Lighting

The purpose of emergency lighting is to provide light in the event of a mains or local power supply failure, therefore having a proper emergency lighting in place is a major concern for the builders. MEGAMAN® TEMPUS has a wide range of products to cater different applications.

- Slim Bulkhead
- Exit box
- Exit Sign
- Recessed Downlight
- Surface Mounted Downlight
- Twinspot
- Emergency Module

MEGAMAN® TEMPUS

FEL70500v0-em
FEL70500v0-em/st

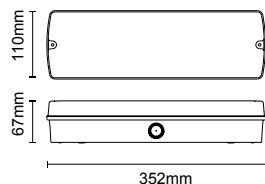
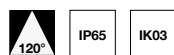

220-240V

White (WH12)

Model No.	Power (W)	Luminous Flux (lm)	Colour Temp.	Battery	Emergency Duration (hrs)	Materials
FEL70500v0-em	4	140	6500K	3.6V 1000mAh Ni-MH	3	Polycarbonate
FEL70500v0-em/st	4	140	6500K	3.6V 1000mAh Ni-MH	3	Polycarbonate

Model No.	Battery	Output Voltage (VDC)	Capacity mAh
LA11171	Ni-MH	3.6	1000

FEL70500v0-em
FEL70500v0-em/st

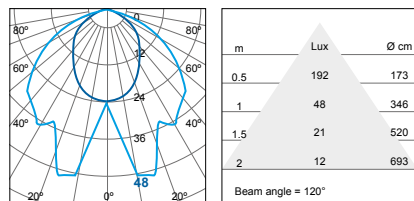

Features

- 3 hours emergency duration
- Maintained / non-maintained operation mode
- IP65 protection from water and dust
- Multi- purpose application
- All direction exit sign stickers included
- Light in weight, easy installation
- Durable polycarbonate housing, corrosion resistant
- Integral status indicator

MEGAMAN® TEMPUS

FEL70600v0-em
FEL70600v0-em/st

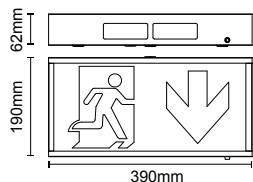
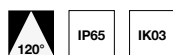

220-240V

White (WH12)

Model No.	Power (W)	Luminous Flux (lm)	Colour Temp.	Battery	Emergency Duration (hrs)	Materials
FEL70600v0-em	5	35	6500K	3.6V 1800mAh Ni-Cd	3	Steel
FEL70600v0-em/st	5	35	6500K	3.6V 1800mAh Ni-Cd	3	Steel

Model No.	Battery	Output Voltage (VDC)	Capacity mAh
LA11172	Ni-Cd	3.6	1800

Features

- 3 hours emergency duration
- Maintained/ Non-maintained operation mode
- Durable steel housing with anti-corrosion powder coating
- Easy exit pictogram mounting
- Integrated downlighter
- Integral status indicator
- Test button

FEL70600v0-em
FEL70600v0-em/st

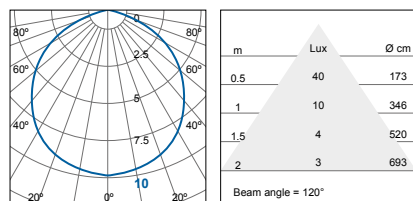

Accessory



LA8089
Direction PVC film,
Arrow left



LA8090
Direction PVC film,
Arrow right

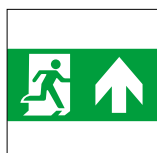

LA8091
Direction PVC film,
Arrow upward

Integrated LED luminaire

MEGAMAN® TEMPUS

FEL70700v0-em



IP20

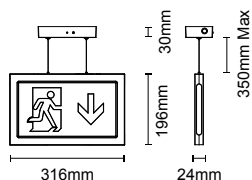

FEL70800v0-em
FEL70800v0-em/st



IP20

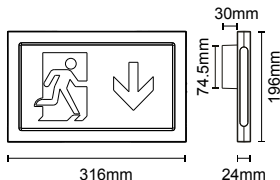

FEL71000v0-em/st



IP20

220-240V

White (WH26)

Installation	Model No.	Power (W)	Luminous Flux (lm)	Colour Temp.	Battery	Emergency Duration (hrs)	Materials
Ceiling/ Cord suspension	FEL70700v0-em	3.5	35	6500K	3.6V 1000mAh Ni-MH	3	Polycarbonate
Wall Mount	FEL70800v0-em	3.5	35	6500K	3.6V 1000mAh Ni-MH	3	Polycarbonate
Wall Mount	FEL70800v0-em/st	3.5	35	6500K	3.6V 1000mAh Ni-MH	3	Polycarbonate
Surface Mount	FEL71000v0-em/st	3.5	35	6500K	3.6V 1000mAh Ni-MH	3	Polycarbonate

Model No.	Battery	Output Voltage (VDC)	Capacity mAh
LA11171	Ni-MH	3.6	1000

Accessory



LA8088
Direction PVC film,
Arrow left (flip over
= Arrow right)



LA8092
Direction PVC film,
Arrow up

Features

- 3 hours emergency duration
- Maintained operation mode
- Flexible ceiling and cord suspended mounted in one fittings (FEL70700v0-em)
- Max. 500mm length suspension cord (FEL70700v0-em)
- Easy mounting 2-side pictogram (FEL70700v0-em)
- Wall mounted (FEL70800v0-em, FEL70800v0-em/st)
- Easy mounting 1-side pictogram (FEL70800v0-em, FEL70800v0-em/st)
- Integral status indicator

MEGAMAN® TEMPUS

FEL70900v0-em
FEL70900v0-em/st



IP20

220-240V

Installation	Model No.	Power (W)	Luminous Flux (lm)	Colour Temp.	Battery	Emergency Duration (hrs)	Materials
Recessed	FEL70900v0-em	3.5	35	6500K	3.6V 1000mAh Ni-MH	3	Aluminium
Recessed	FEL70900v0-em/st	3.5	35	6500K	3.6V 1000mAh Ni-MH	3	Aluminium

Model No.	Battery	Output Voltage (VDC)	Capacity mAh
LA11171	Ni-MH	3.6	1000

Features

- 3 hours emergency duration
- Maintained operation mode
- Flexible ceiling and cord suspended mounted in one fittings (FEL70700v0-em)
- Max. 500mm length suspension cord (FEL70700v0-em)
- Easy mounting 2-side pictogram (FEL70700v0-em)
- Wall mounted (FEL70800v0-em, FEL70800v0-em/st)
- Easy mounting 1-side pictogram (FEL70800v0-em, FEL70800v0-em/st)
- Integral status indicator

Accessory



LA8088
Direction PVC film,
Arrow left (flip over
= Arrow right)



LA8092
Direction PVC film,
Arrow up

MEGAMAN® TEMPUS

FEL70300v0-em
FEL70300v0-em/st



FEL70400v0-em
FEL70400v0-em/st



IP54

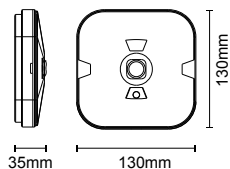

IP54

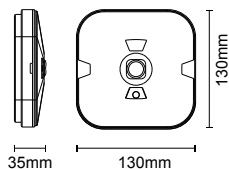

220-240V

White (WH12)

Model No.	Emergency Power (Max. W)	Luminous Flux (lm)	Colour Temp.	Battery	Emergency Duration (hrs)	Materials
FEL70300v0-em	3	130	6000K	3.3V 1500mAh LiFePO ₄	3	Polycarbonate
FEL70300v0-em/st	3	130	6000K	3.3V 1500mAh LiFePO ₄	3	Polycarbonate
FEL70400v0-em	3	130	6000K	3.3V 1500mAh LiFePO ₄	3	Polycarbonate
FEL70400v0-em/st	3	130	6000K	3.3V 1500mAh LiFePO ₄	3	Polycarbonate

Model No.	Battery	Output Voltage (VDC)	Capacity mAh
LA11174	LiFePO ₄	3.2	1500

Features

- 3 hours emergency duration
- Non-maintained operation mode
- IP54 Protection
- Compact in size
- Advanced LiFePO₄ battery
- Touch testing button
- Open area and corridor optics versions available
- Comply with EN 60598-2-22, UN 38.3 and IES 62133
- Overcharge and over-discharge protection, over-temperature protection, short circuit protection
- Integral status indicator

FEL70300v0-em
FEL70300v0-em/st

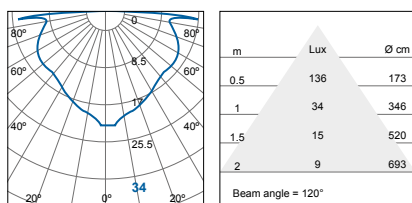

FEL70400v0-em
FEL70400v0-em/st

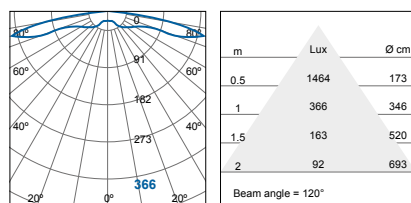

MEGAMAN® TEMPUS

FEL71100v0-em+018D
FEL71100v0-em/st+018D



FEL71100v0-em+045D
FEL71100v0-em/st+045D



IP54

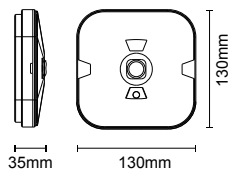

IP54

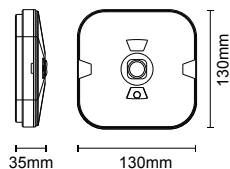

220-240V

White (WH12)

Model No.	Emergency Power (Max. W)	Luminous Flux (lm)	Beam Angle (°)	Colour Temp.	Battery	Emergency Duration (hrs)	Materials
FEL71100v0-em+018D	3	200	18	6000K	3.2V 3000mAh LiFePO4	3	Polycarbonate
FEL71100v0-em/st+018D	3	200	18	6000K	3.2V 3000mAh LiFePO4	3	Polycarbonate
FEL71100v0-em+045D	3	200	45	6000K	3.2V 3000mAh LiFePO4	3	Polycarbonate
FEL71100v0-em/st+045D	3	200	45	6000K	3.2V 3000mAh LiFePO4	3	Polycarbonate

Model No.	Battery	Output Voltage (VDC)	Capacity mAh
LA11203	LiFePO ₄	6.4	1500

FEL71100v0-em+018D
FEL71100v0-em/st+018D

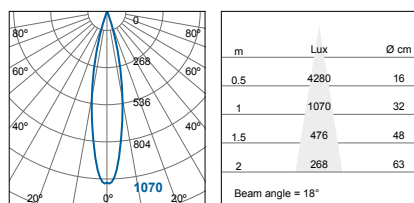

FEL71100v0-em+045D
FEL71100v0-em/st+045D

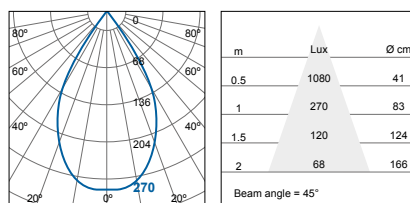

Features

- 3 hours emergency duration
- Non-maintained operation mode
- IP54 Protection
- Compact in size
- Advanced LiFePO₄ battery
- Touch testing button
- Highbay optics and Midbay optics available
- Comply with EN 60598-2-22, UN 38.3 and IES 62133
- Overcharge and over-discharge protection, over-temperature protection, short circuit protection
- Integral status indicator

MEGAMAN® TEMPUS

FEL70100v0-em
FEL70100v0-em/st



IP20

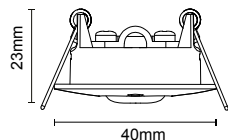

FEL70200v0-em
FEL70200v0-em/st



IP20

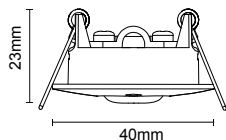

220-240V

White (WH12)

Model No.	Emergency Power (Max. W)	Luminous Flux (lm)	Colour Temp.	Battery	Emergency Duration (hrs)	Materials
FEL70100v0-em	3	120	6000K	3.3V 1500mAh LiFePO ₄	3	Polycarbonate
FEL70100v0-em/st	3	120	6000K	3.3V 1500mAh LiFePO ₄	3	Polycarbonate
FEL70200v0-em	3	120	6000K	3.3V 1500mAh LiFePO ₄	3	Polycarbonate
FEL70200v0-em/st	3	120	6000K	3.3V 1500mAh LiFePO ₄	3	Polycarbonate

Model No.	Battery	Output Voltage (VDC)	Capacity mAh
LA11174	LiFePO ₄	3.2	1500

Features

- 3 hours emergency duration
- Non-maintained operation mode
- 850°C glow-wiring test
- Super slim design
- Advanced LiFePO₄ battery
- SELV Constant current output
- Comply with EN 60598-2-22, UN 38 3 and IES 62133
- Overcharge and over-discharge protection, over-temperature protection, short circuit protection
- Integral status indicator

FEL70100v0-em
FEL70100v0-em/st

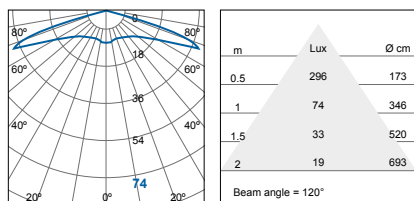

FEL70200v0-em
FEL70200v0-em/st

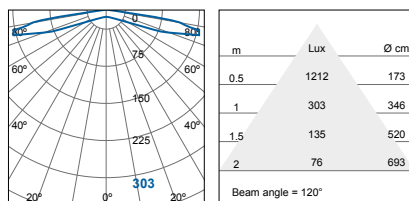

MEGAMAN® TEMPUS

FEL7000v0-em
FEL7000v0-em/st



IP65 Class II

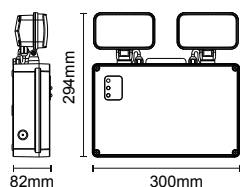

220-240V

White (WH12)

Model No.	Emergency Power (Max. W)	Luminous Flux (lm)	Colour Temp.	Emergency Duration (hrs)	Materials
FEL7000v0-em	2.3	400	6500K	3	Polycarbonate
FEL7000v0-em/st	2.3	400	6500K	3	Polycarbonate

Model No.	Battery	Output Voltage (VDC)	Capacity mAh
LA11173	Ni-Cd	12	1500

FEL7000v0-em
FEL7000v0-em/st

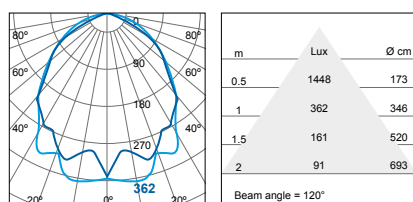

Features

- 3 hours emergency duration
- Non-maintained operation mode
- IP65 protection from water and dust
- Light in weight, easy installation
- Rotate and tilt lighting direction
- Polycarbonate diffuser, corrosion resistant
- Integral status indicator

MEGAMAN® TEMPUS

LA11175
LA11192

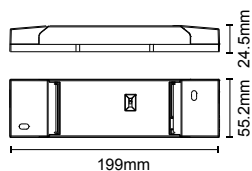

220-240V

White (WH12)

Model No.	Emergency Power (Max. W)	Output Voltage (VDC)	Emergency Duration (hrs)	Materials
LA11175	4	10-90	3	Polycarbonate
LA11192	4	10-90	3	Polycarbonate

Model No.	Battery	Output Voltage (VDC)	Capacity mAh
LA11176	LiFePO ₄	6.4	1500

Features

- 3 hours emergency duration
- 850°C Glow-wiring test
- Compact size
- Advanced plug-in LiFePO₄ battery
- Included testing button and integral status indicator Flexible for LED module with a forward voltage of 10-90VDC
- Compatible with all dimmable and non-dimmable constant current LED driver
- Over-charge and over discharge protection, over temperature protection and short circuit protection

MEGAMAN® TEMPUS

LA11199
LA11200

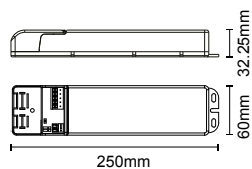

220-240V

White (WH12)

Model No.	Emergency Power (Max. W)	Output Voltage (VDC)	Emergency Duration (hrs)	Materials
LA11199	4	80-230	3	Polycarbonate
LA11200	4	80-230	3	Polycarbonate

Model No.	Battery	Output Voltage (VDC)	Capacity mAh
LA11176	LiFePO ₄	6.4	1500

Features

- 3 hours emergency duration
- 850°C Glow-wiring test
- Compact size
- Advanced plug-in LiFePO₄ battery
- Included testing button and integral status indicator Flexible for LED module with a forward voltage of 10-90VDC
- Compatible with all dimmable and non-dimmable constant current LED driver
- Over-charge and over discharge protection, over temperature protection and short circuit protection

MEGAMAN® HUGO



NEW



Outdoor Lighting / Floodlight
MEGAMAN® HUGO



MEGAMAN® HUGO

Outdoor Integrated LED Floodlight

MEGAMAN® HUGO with smart looking aluminium die-cast housing and stainless-steel bracket to have an anti-corrosion function which is perfect for building near sea side applications. MEGAMAN® HUGO is the most versatile and adaptable floodlights suitable for outdoor application from parking lots, recreational sports or industrial lighting to large public areas. Symmetrical / Asymmetrical optics can be used in a wide range of application. MEGAMAN® HUGO floodlight boasts a high efficiency of up to 150lm/W, providing bright and illumination to any outdoor space. With IP66 rated fully waterproof enclosure, it is resistant to dust and water, making it suitable for use in all weather conditions. Furthermore, the MEGAMAN® HUGO floodlight has a long lifespan of up to 50,000 hours, reducing maintenance costs and ensuring reliable performance for years to come.

Features

- Anti-corrosion function thanks to stainless-steel mounting bracket and aluminium die-cast housing
- Switching CCT and selectable lumen output ensure the flexibility and convenience of application
- High luminous efficiency up to 150 lm/W
- Symmetrical / Asymmetrical optics can be used in a wide range of application areas
- Energy savings of up to 90% compared to halogen lamp floodlights
- Energy savings of up to 45% compared to luminaires that use conventional discharge lamps
- High surge protection: up to 6 kV (L/N-PE), 6 kV (L-N)
- Tilt-angle degree marks on 70/90W and 120/150W for accurate tilting adjustment
- Air ventilating gland for air pressure balancing
- IP66 rated fully waterproof enclosure
- IK08 for high impact resistance

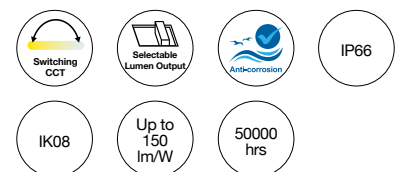

Applications

- Buildings near sea side
- Parking lots
- Outdoor sports and stadium
- For recreational sports (tennis courts, basketball courts...)
- Industry
- Public areas

MEGAMAN® HUGO

FFL75700v0-ds/sc
FFL75700v0-ds

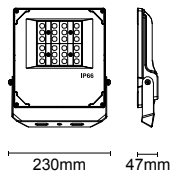
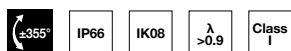

FFL75800v0-ds/sc
FFL75800v0-ds

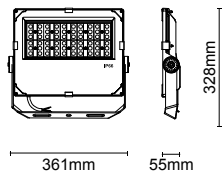

FFL75900v0-ds/sc
FFL75900v0-ds

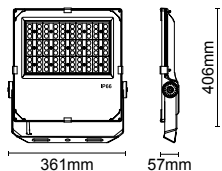

220-240V

Black (BK12)

ANTI-CORROSION VERSION

Model No.	Wattage (W)	Luminous Flux (lm)	Colour Temp.	Beam Angle	Dimension (mm)	Rated Life at L80B50 @Ta25°C (hrs)	Materials
FFL75700v0-ds/sc	50/22	6000lm [50W 3000K] 7300lm [50W 4000K] 6500lm [50W 5700K] 2750lm [22W 3000K] 3300lm [22W 4000K] 2860lm [22W 5700K]	3000/4000/5700K CCT Switchable	Symmetric Optic 60°/90°	L268 x H230 x D47mm	70,000	Die-casting aluminium Housing, Stainless steel 304 bracket
FFL75700v0-ds	50/22	6000lm [50W 3000K] 6800lm [50W 4000K] 6800lm [50W 5700K] 2860lm [22W 3000K] 3080lm [22W 4000K] 3080lm [22W 5700K]	3000K/4000K/5700K Single CCT	Asymmetric Optic TP3A, 110° x 40°, 135° x 60°	L268 x H230 x D47mm	70,000	Die-casting aluminium Housing, Stainless steel 304 bracket
FFL75800v0-ds/sc	90/70	12200lm [90W 3000K] 13500lm [90W 4000K] 13000lm [90W 5700K] 9500lm [70W 3000K] 10500lm [70W 4000K] 10200lm [70W 5700K]	3000/4000/5700K CCT Switchable	Symmetric Optic 60°/90°/120°	L328 x H361 x D55mm	70,000	Die-casting aluminium Housing, Stainless steel 304 bracket
FFL75800v0-ds	90/70	12200lm [90W 3000K] 13000lm [90W 4000K] 13000lm [90W 5700K] 9800lm [70W 3000K] 10500lm [70W 4000K] 10500lm [70W 5700K]	3000K/4000K/5700K Single CCT	Asymmetric Optic TP3A, 110° x 40°, 135° x 60°	L328 x H361 x D55mm	70,000	Die-casting aluminium Housing, Stainless steel 304 bracket
FFL75900v0-ds/sc	150/120	20500lm [150W 3000K] 22500lm [150W 4000K] 22000lm [150W 5700K] 15700lm [120W 3000K] 18000lm [120W 4000K] 17500lm [120W 5700K]	3000/4000/5700K CCT Switchable	Symmetric Optic 60°/90°/120°	L406 x H361 x D57mm	70,000	Die-casting aluminium Housing, Stainless steel 304 bracket
FFL75900v0-ds	150/120	20500lm [150W 3000K] 22000lm [150W 4000K] 22000lm [150W 5700K] 15700lm [120W 3000K] 18000lm [120W 4000K] 18000lm [120W 5700K]	3000K/4000K/5700K Single CCT	Asymmetric Optic TP3A, 110° x 40°, 135° x 60°	L406 x H361 x D57mm	70,000	Die-casting aluminium Housing, Stainless steel 304 bracket

Outdoor Lighting / Floodlight

MEGAMAN® HUGO

FFL76000v0-ds/sc
FFL76000v0-ds



FFL76100v0-ds/sc
FFL76100v0-ds

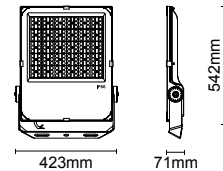
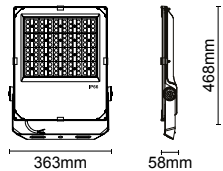

220-240V

Black (BK12)

ANTI-CORROSION VERSION

Model No.	Wattage (W)	Luminous Flux (lm)	Colour Temp.	Beam Angle	Dimension (mm)	Rated Life at L80B50 @Ta25°C (hrs)	Materials
FFL76000v0-ds/sc	200	27000lm [3000K] 30000lm [4000K] 28000lm [5700K]	3000/4000/5700K CCT Switchable	Symmetric Optic 60°/90°/120°	L468 x H363 x D58mm	70,000	Die-casting aluminium Housing, Stainless steel 304 bracket
FFL76000v0-ds	200	27000lm [3000K] 29000lm [4000K] 29000lm [5700K]	3000K/4000K/5700K Single CCT	Asymmetric Optic TP3A, 110° x 40°, 135° x 60°	L468 x H363 x D58mm	70,000	Die-casting aluminium Housing, Stainless steel 304 bracket
FFL76100v0-ds/sc	300	45000lm [3000K] 48000lm [4000K] 48000lm [5700K]	3000/4000/5700K CCT Switchable	Symmetric Optic 60°/90°/120°	L542 x H423 x D71mm	70,000	Die-casting aluminium Housing, Stainless steel 304 bracket
FFL76100v0-ds	300	45000lm [3000K] 48000lm [4000K] 48000lm [5700K]	3000K/4000K/5700K Single CCT	Asymmetric Optic TP3A, 110° x 40°, 135° x 60°	L542 x H423 x D71mm	70,000	Die-casting aluminium Housing, Stainless steel 304 bracket

MEGAMAN® HUGO

FFL74100v0-ds/sc
FFL74100v0-ds



±355° IP66 IK08 λ >0.9 Class I

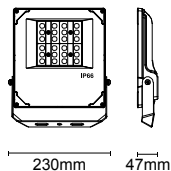

FFL74200v0-ds/sc
FFL74200v0-ds



±355° IP66 IK08 λ >0.9 Class I

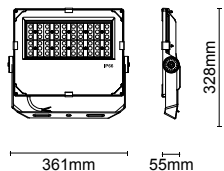

FFL74300v0-ds/sc
FFL74300v0-ds



±355° IP66 IK08 λ >0.9 Class I

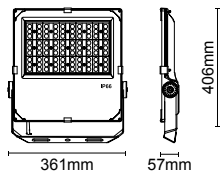

220-240V

Black (BK12)

STANDARD VERSION

Model No.	Wattage (W)	Luminous Flux (lm)	Colour Temp.	Beam Angle	Dimension (mm)	Rated Life at L80B50 @Ta25°C (hrs)	Materials
FFL74100v0-ds/sc	50/22	6000lm [50W 3000K] 7300lm [50W 4000K] 6500lm [50W 5700K] 2750lm [22W 3000K] 3300lm [22W 4000K] 2860lm [22W 5700K]	3000/4000/5700K CCT Switchable	Symmetric Optic 60°/90°	L268 x H230 x D47mm	70,000	Die-casting aluminium
FFL74100v0-ds	50/22	6000lm [50W 3000K] 6800lm [50W 4000K] 6800lm [50W 5700K] 2860lm [22W 3000K] 3080lm [22W 4000K] 3080lm [22W 5700K]	3000K/4000K/5700K Single CCT	Asymmetric Optic TP3A, 110x40, 135x60	L268 x H230 x D47mm	70,000	Die-casting aluminium
FFL74200v0-ds/sc	90/70	12200lm [90W 3000K] 13500lm [90W 4000K] 13000lm [90W 5700K] 9500lm [70W 3000K] 10500lm [70W 4000K] 10200lm [70W 5700K]	3000/4000/5700K CCT Switchable	Symmetric Optic 60°/90°/120°	L328 x H361 x D55mm	70,000	Die-casting aluminium
FFL74200v0-ds	90/70	12200lm [90W 3000K] 13000lm [90W 4000K] 13000lm [90W 5700K] 9800lm [70W 3000K] 10500lm [70W 4000K] 10500lm [70W 5700K]	3000K/4000K/5700K Single CCT	Asymmetric Optic TP3A, 110x40, 135x60	L328 x H361 x D55mm	70,000	Die-casting aluminium
FFL74300v0-ds/sc	150/120	20500lm [150W 3000K] 22500lm [150W 4000K] 22000lm [150W 5700K] 15700lm [120W 3000K] 18000lm [120W 4000K] 17500lm [120W 5700K]	3000/4000/5700K CCT Switchable	Symmetric Optic 60°/90°/120°	L406 x H361 x D57mm	70,000	Die-casting aluminium
FFL74300v0-ds	150/120	20500lm [150W 3000K] 22000lm [150W 4000K] 22000lm [150W 5700K] 15700lm [120W 3000K] 18000lm [120W 4000K] 18000lm [120W 5700K]	3000K/4000K/5700K Single CCT	Asymmetric Optic TP3A, 110x40, 135x60	L406 x H361 x D57mm	70,000	Die-casting aluminium

Outdoor Lighting / Floodlight

MEGAMAN® HUGO

FFL74900v0-sc
FFL74900v0



FFL75000v0-sc
FFL75000v0

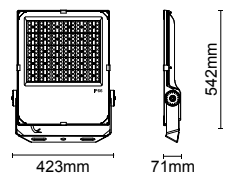
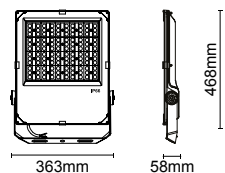

220-240V

Black (BK12)

STANDARD VERSION

Model No.	Wattage (W)	Luminous Flux (lm)	Colour Temp.	Beam Angle	Dimension (mm)	Rated Life at L80B50 @Ta25°C (hrs)	Materials
FFL74900v0-sc	200	27000lm [3000K] 30000lm [4000K] 28000lm [5700K]	3000/4000/5700K CCT Switchable	Symmetric Optic 60°/90°/120°	L468 x H363 x D58mm	70,000	Die-casting aluminium
FFL74900v0	200	27000lm [3000K] 30000lm [4000K] 28000lm [5700K]	3000K/4000K/5700K Single CCT	Asymmetric Optic TP3A, 110x40, 135x60	L468 x H363 x D58mm	70,000	Die-casting aluminium
FFL75000v0-sc	300	45000lm [3000K] 48000lm [4000K] 48000lm [5700K]	3000/4000/5700K CCT Switchable	Symmetric Optic 60°/90°/120°	L542 x H423 x D71mm	70,000	Die-casting aluminium
FFL75000v0	300	45000lm [3000K] 48000lm [4000K] 48000lm [5700K]	3000K/4000K/5700K Single CCT	Asymmetric Optic TP3A, 110x40, 135x60	L542 x H423 x D71mm	70,000	Die-casting aluminium

Accessory

Stainless steel 304 bracket



LA10226
for 50W only



LA10227
for 90 - 200W



LA10228
for 300W only

MEGAMAN® HUGO



IP66
MEGAMAN®

Symmetrical optics: 120°

Symmetrical optics: 60° / 90°

Asymmetrical optics: TP3A, 110°x40°
135°x60°

Selectable Lumen Output

Switching CCT

Selectable Lumen Output and Switching CCT

1.5M rubber cable with waterproof quick connector

Stainless-steel screw and mounting bracket with coating as standard version

Stainless-steel screw and stainless-steel mounting bracket as anti-corrosion version



Anti-corrosion

MEGAMAN® HUGO

HUGO Photometric Data (Symmetric Optic)

FFL74100v0-ds/sc+060D-22W

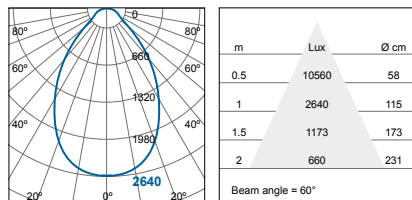

FFL74100v0-ds/sc+090D-22W

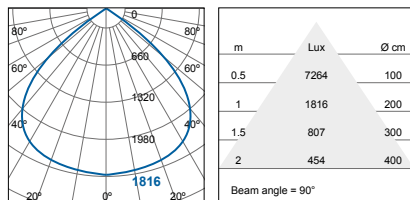

FFL74100v0-ds/sc+060D-50W

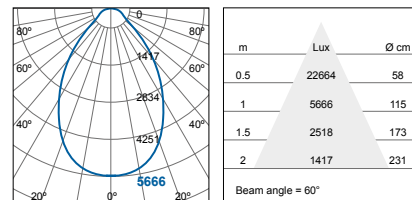

FFL74100v0-ds/sc+090D-22W

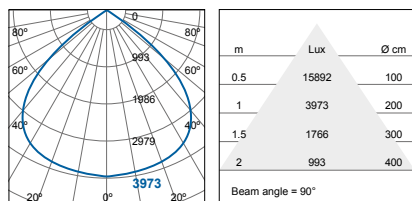

FFL74200v0-ds/sc+060D-70W
FFL74200v0-ds+060D-70W

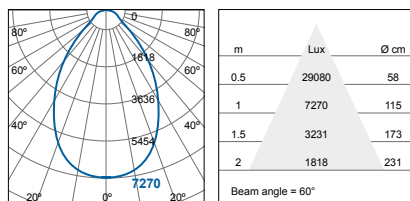

FFL74200v0-dssc+090D-70W
FFL74200v0-ds+090D-70W

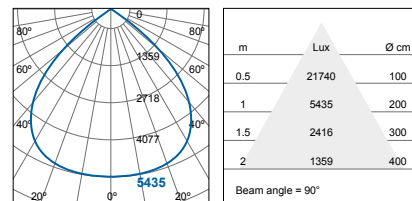

FFL74200v0-ds/sc+060D-90W
FFL74200v0-ds+060D-90W

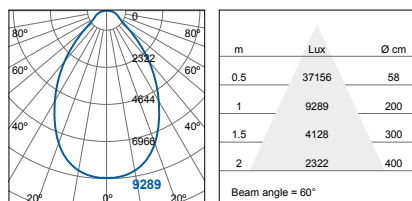

FFL74300v0-dssc+060D-120W
FFL74300v0-ds+060D-120W

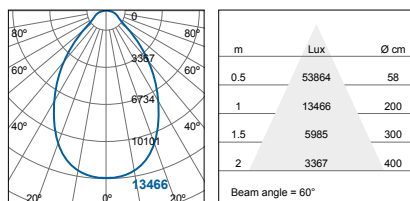

FFL74300v0-dssc+090D-120W
FFL74300v0-ds+090D-120W

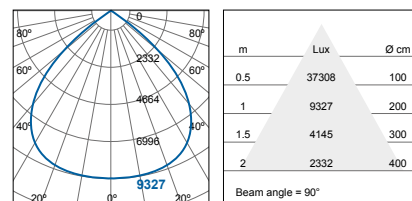

FFL74300v0-dssc+060D-150W
FFL74300v0-ds+060D-150W

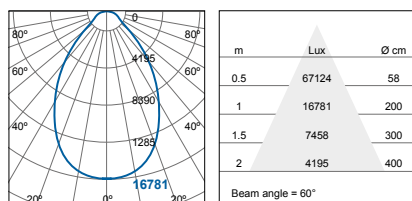

FFL74300v0-dssc+090D-150W
FFL74300v0-ds+090D-150W

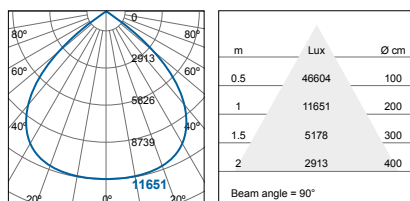

FFL74900v0-sc+060D-200W

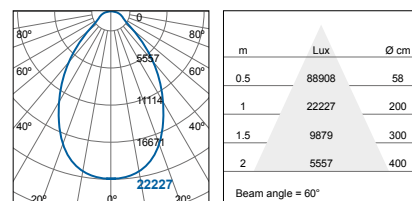

FFL74900v0-sc+090D-200W

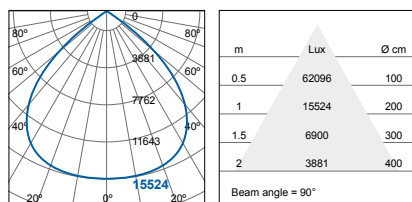

FFL75000v0-sc+060D-300W

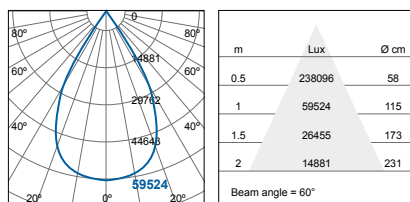

FFL75000v0-sc+090D-300W

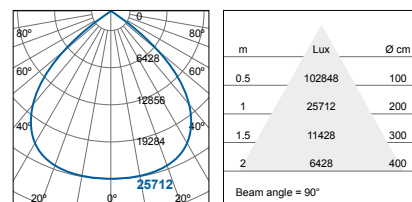

MEGAMAN® HUGO



MEGAMAN® TITO





MEGAMAN® TITO

Outdoor Integrated LED Floodlight

MEGAMAN® TITO is a dedicated LED floodlight with efficient and versatile, this series has six different lumen package with five different housing sizes. MEGAMAN® TITO is with corrosion resistant aluminium housing, together with IP66 and IK08 ratings. It is up to 4kV surge protection to against the instant voltage fluctuation, it allows MEGAMAN® TITO to be an ideal solution for outdoor application.

Features

- Perfect replacement of discharge lamp floodlights
- Energy saving up to 60%
- Easy installation by simply connect with power cable
- Robust die-cast aluminium body, with slim and efficient heat dissipation profile
- Instant light with flicker free performance
- Extra-long lifetime with 50,000hrs
- Fast payback and low total cost of ownership with energy savings and minimum maintenance costs
- IP66 rated fully waterproof enclosure
- IK08 for high impact resistance
- High surge protection up to 6kv (l/n-pe) and 4kv (l-n)
- Equipped with 1m cable
- Symmetric and asymmetric version are available



Applications

- Sport facilities
- Stadiums
- Industrial areas
- Façade
- Billboards

MEGAMAN® TITO

FFL71100v0

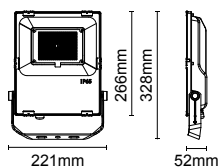

FFL71200v0

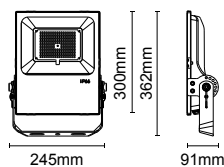

FFL71200v1

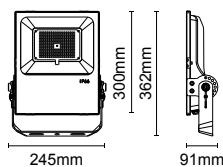

FFL71300v0

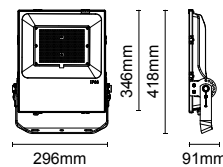
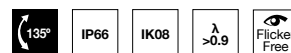

220-240V

Black (BK24)

Symmetrical Floodlight

Model No.	Wattage (W)	Luminous Flux (lm)	Lm/W	Colour Temp.	CRI	Max. Luminous Intensity (cd)	Dimension (mm)	Rated Life at L70 B50 at Ta25°C (hrs)	Materials
FFL71100v0	70	10000	143	4000K	80	3900 [110°]	L220 x W52 x H265	50000	Aluminum die cast housing + Tempered glass diffuser
FFL71200v0	90	13300	148	4000K	80	5200 [110°]	L245 x W91 x H300	50000	Aluminum die cast housing + Tempered glass diffuser
FFL71200v1	120	18200	152	4000K	80	6900 [110°]	L245 x W91 x H300	50000	Aluminum die cast housing + Tempered glass diffuser
FFL71300v0	165	27000	164	4000K	80	9400 [110°]	L295 x W91 x H345	50000	Aluminum die cast housing + Tempered glass diffuser

FFL71100v0

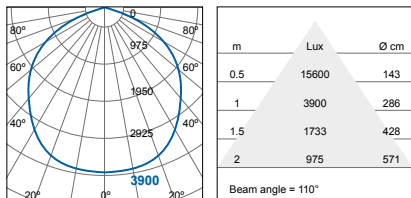

FFL71200v0

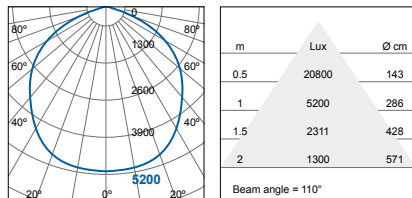

FFL71200v1

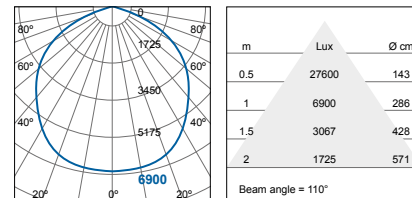

FFL71300v0

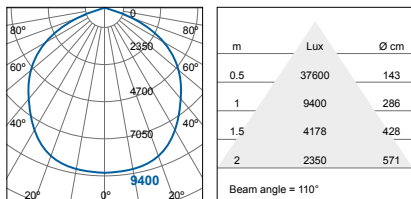

Outdoor Lighting / Floodlight

MEGAMAN® TITO

FFL72900v0+045A085A

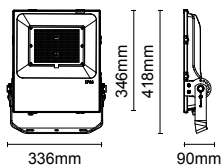

FFL73000v0+045A085A

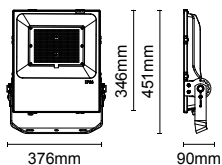

220-240V

Black (BK24)

Asymmetrical Floodlight

Model No.	Wattage (W)	Luminous Flux (lm)	Beam angle (°)	Colour Temp.	CRI	Max. Luminous Intensity (cd)	Dimension (mm)	Rated Life at L70 B50 at Ta25°C (hrs)	Materials
FFL72900v0+045A085A NEW	115	14500	Asymmetrical 45 x 85	4000K	80	TBA	L336 x W90 x H416	50000	Aluminum die cast housing + Tempered glass diffuser
FFL73000v0+045A085A NEW	152	18500	Asymmetrical 45 x 85	4000K	80	19000	L376 x W90 x H451	50000	Aluminum die cast housing + Tempered glass diffuser

FFL73000v0+045A085A

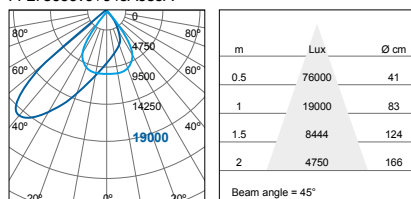

MEGAMAN® EKON

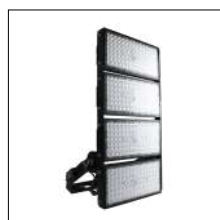

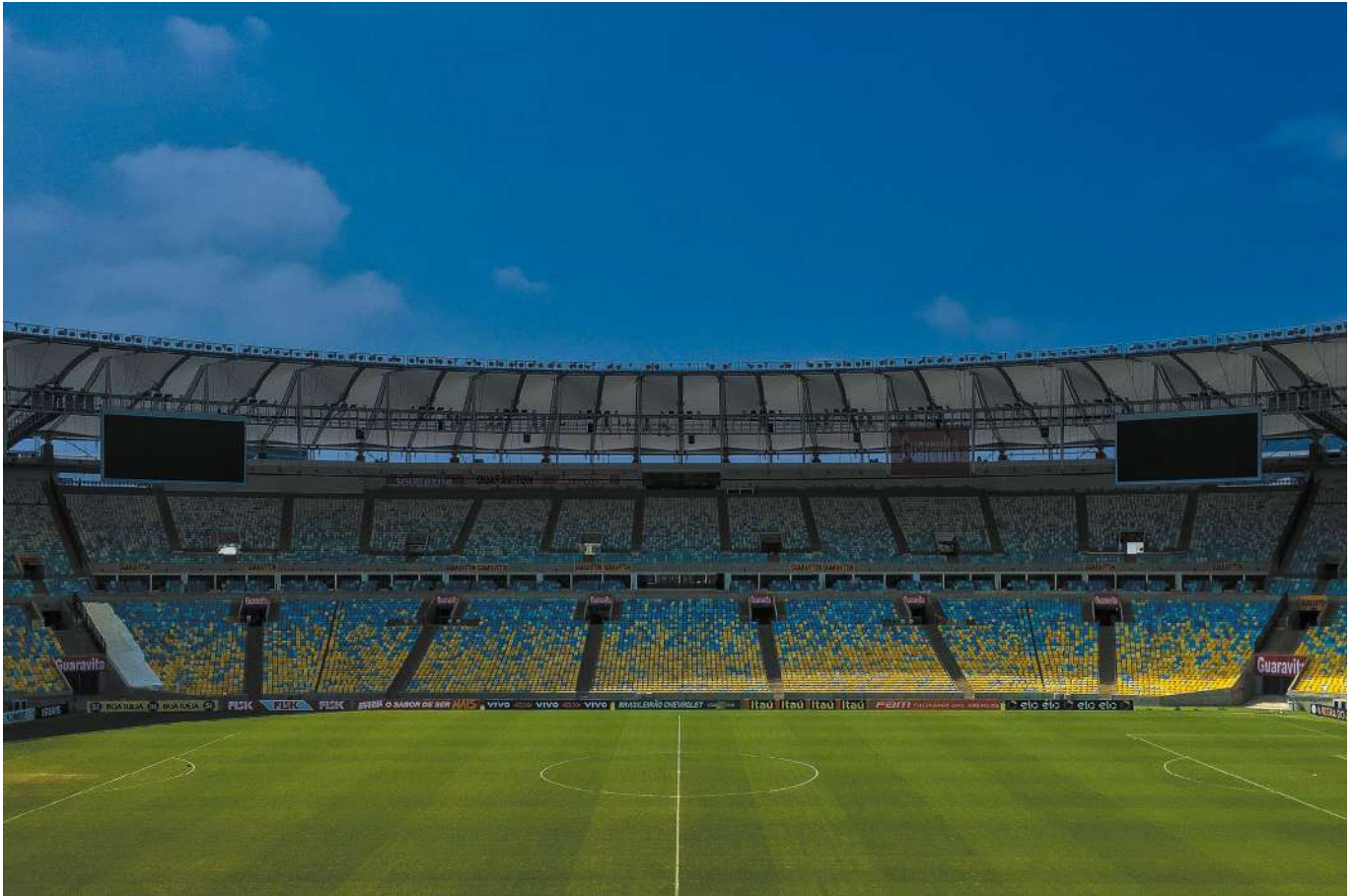

MEGAMAN® EKON

Outdoor Integrated LED Floodlight

MEGAMAN® EKON is an outdoor stadium floodlight provides superb brightness and gives instant light with a homogeneous illumination and perfect for outdoor applications. MEGAMAN® EKON delivers superb performance up to 140lm/W and has a substantial 50,000 hours lifetime. Strong and durable powder coated aluminum housing allows protection against corrosion. MEGAMAN® EKON offers symmetric and asymmetric options for uniform lighting, which delivers highly focused light beams, low glare and enhanced photometric control. With fully adjustable 180 degree joints, allows to project the light at different angles.

Features

- Modular design from 250W to 1250W for high mounting application
- Vertically angle adjustment, easy way to adjust the tilting angle and create diversity of lighting environment
- Multiple optics option: symmetrical optics from 10° to 90°; asymmetrical optics 130°x25° / 130°x60° to provide wide lighting application
- Excellent optical glare control avoids light pollution
- Aluminum die-casting housing, driver box and bracket with anti-corrosion powder coating finishing
- Efficiency up to 140lm/W, more energy saving
- 10kV (L-N) / 20kV (LN-G) Surge Protection
- Coupled with water resistance at IP66 protection
- High vandal resistant with IK09
- 50,000hrs L80B10 at Ta 30°C

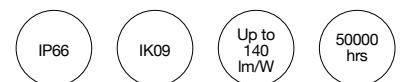

Applications

- Parking lots
- Outdoor sports and stadium square
- For recreational sports (tennis courts, basketball courts...)
- Exhibition centre
- Soccer field

MEGAMAN® EKON

FFL73600v0

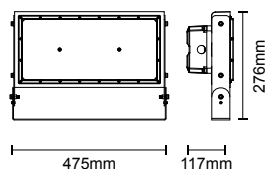

FFL73700v0

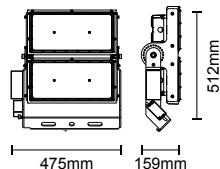
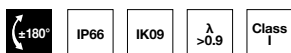

FFL73800v0

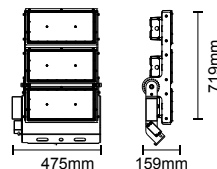
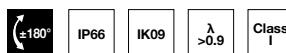

220-240V

Black (BK24)

Symmetrical

Model No.	Wattage (W)	Luminous Flux (lm)	Efficiency Lm/W	Colour Temp. (CRI)	Beam Angle (°)	Dimension (mm)	Rated Lifetime L80B10@Ta30°C	Power Factor (λ)
FFL73600v0	250	35000	140	4000K/5000K/5700K [80]	10°/25°/45°/60°/90°	L276 x W475 x H117	50000	>0.95
FFL73700v0	500	70000	140	4000K/5000K/5700K [80]		L512 x W475 x H159	50000	>0.95
FFL73800v0	750	105000	140	4000K/5000K/5700K [80]		L719 x W475 x H159	50000	>0.95

Asymmetrical

Model No.	Wattage (W)	Luminous Flux (lm)	Efficiency Lm/W	Colour Temp. (CRI)	Beam Angle (°)	Dimension (mm)	Rated Lifetime L80B10@Ta30°C	Power Factor (λ)
FFL73600v0 NEW	250	35000	140	4000K/5000K/5700K [80]	130°*25°/130°*60°	L276 x W475 x H117	50000	>0.95
FFL73700v0 NEW	500	70000	140	4000K/5000K/5700K [80]		L512 x W475 x H159	50000	>0.95
FFL73800v0 NEW	750	105000	140	4000K/5000K/5700K [80]		L719 x W475 x H159	50000	>0.95

FFL73700v0+025D

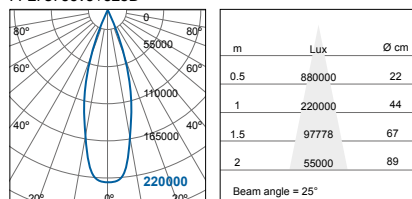

Outdoor Lighting / Floodlight

MEGAMAN® EKON

FFL73900v0

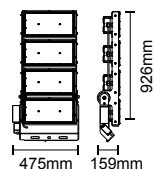
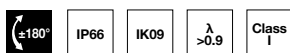

FFL74000v0

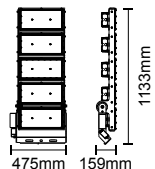

220-240V

Black (BK24)

Symmetrical

Model No.	Wattage (W)	Luminous Flux (lm)	Efficiency Lm/W	Colour Temp. (CRI)	Beam Angle (°)	Dimension (mm)	Rated Lifetime L80B10@Ta30°C	Power Factor (λ)
FFL73900v0	1000	140000	140	4000K/5000K/5700K [80]	10°/25°/45°/60°/90°	L926 x W475 x H159	50000	>0.95
FFL74000v0	1250	175000	140	4000K/5000K/5700K [80]		L1133 x W475 x H159	50000	>0.95

Asymmetrical

Model No.	Wattage (W)	Luminous Flux (lm)	Efficiency Lm/W	Colour Temp. (CRI)	Beam Angle (°)	Dimension (mm)	Rated Lifetime L80B10@Ta30°C	Power Factor (λ)
FFL73900v0 NEW	1000	140000	140	4000K/5000K/5700K [80]	130°*25°/130°*60°	L926 x W475 x H159	50000	>0.95
FFL74000v0 NEW	1250	175000	140	4000K/5000K/5700K [80]		L1133 x W475 x H159	50000	>0.95

FFL73900v0+025D

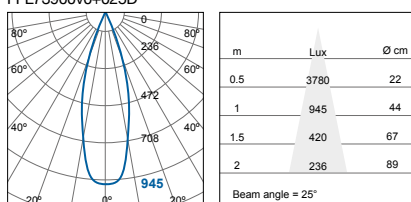



 is available for 10W, 20W, 30W & 50W
PIR Sensor

Outdoor Lighting / Floodlight
MEGAMAN® VOSS



MEGAMAN® VOSS

Outdoor Integrated LED Floodlight

MEGAMAN® VOSS is an integrated LED floodlight with slim and efficient heat dissipation profile offers wide range of lumen packages with a cost competitive solution. Equipped with a u-shaped bracket, the luminaire can be rotated 180° adjustment for lighting. PIR motion sensor version available for energy saving and safety consideration.

Features

- Durable die cast aluminum with anti-corrosion powder coating and tempered glass
- Efficient heat dissipation
- Beam angle 110°
- IP65 waterproof for standard and IP54 for PIR Sensor version
- IK08 rated vandal resistant
- With 0.5m H05RN-F 3G1.0mm² cable
- Standard version is available for 10W, 20W, 30W, 50W, 100W, 150W & 200W
- PIR sensor version is available for 10W, 20W, 30W & 50W
- Fixing bracket adjustable up to 180°

Accessory



LA8143 – Extension arm



Applications

- Industrial areas
- Warehouse
- Façade
- Billboards
- Gate areas

MEGAMAN® VOSS

FFL71800v0

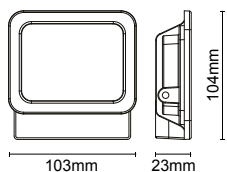

FFL71900v0

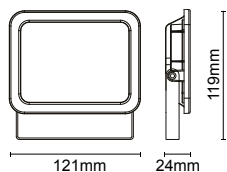

FFL72000v0

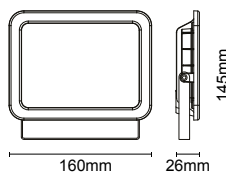

FFL72100v0

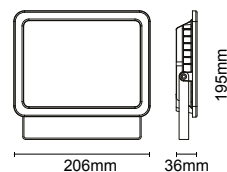

220-240V

Black (BK13)

Model No.	Wattage (W)	Luminous Flux (lm)	Lm/W	Colour Temp.	CRI	Beam Angle(°)	Max. Luminous Intensity (cd)	Dimension (mm)	Rated Life at L70 B50 at Ta25°C (hrs)	Materials
FFL71800v0	10	850 [3000K] 900 [4000K]	85 [3000K] 90 [4000K]	3000K / 4000K	80	110	400	L103 x W23 x H104	30000	Aluminum housing with tempered glass
FFL71900v0	20	1700 [3000K] 1800 [4000K]	85 [3000K] 90 [4000K]	3000K / 4000K	80	110	750	L121 x W24 x H119	30000	Aluminum housing with tempered glass
FFL72000v0	30	2550 [3000K] 2700 [4000K]	85 [3000K] 90 [4000K]	3000K / 4000K	80	110	1100	L160 x W26 x H145	30000	Aluminum housing with tempered glass
FFL72100v0	50	4250 [3000K] 4500 [4000K]	85 [3000K] 90 [4000K]	3000K / 4000K	80	110	1800	L206 x W36 x H195	30000	Aluminum housing with tempered glass

* Open wire version : 0.5m H05RN-F 3G1.0mm² cable

FFL71800v0

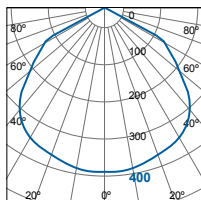

m	Lux	Ø cm
0.5	1600	143
1	400	286
1.5	178	428
2	100	571

Beam angle = 110°

FFL72000v0

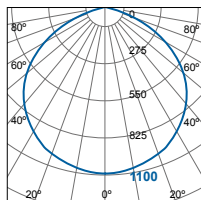

m	Lux	Ø cm
0.5	4400	143
1	1100	286
1.5	489	428
2	275	571

Beam angle = 110°

FFL71900v0

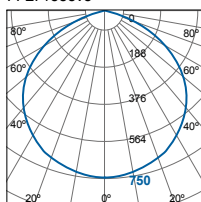

m	Lux	Ø cm
0.5	3000	143
1	750	286
1.5	333	428
2	188	571

Beam angle = 110°

FFL72100v0

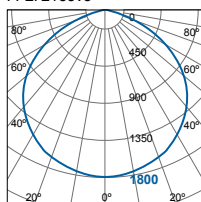

m	Lux	Ø cm
0.5	7200	143
1	1800	286
1.5	800	428
2	450	571

Beam angle = 110°

Outdoor Lighting / Floodlight

MEGAMAN® VOSS

FFL72200v0

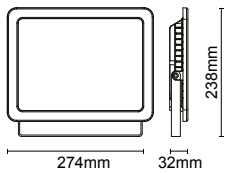

FFL72300v0

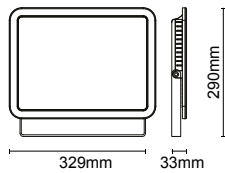

FFL72400v0

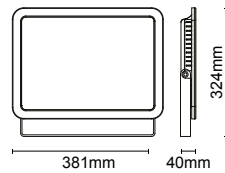

220-240V

Black (BK13)

Model No.	Wattage (W)	Luminous Flux (lm)	Lm/W	Colour Temp.	CRI	Beam Angle(°)	Max. Luminous Intensity (cd)	Dimension (mm)	Rated Life at L70 B50 at Ta25°C (hrs)	Materials
FFL72200v0	100	8500 [3000K] 9000 [4000K]	85 [3000K] 90 [4000K]	3000K / 4000K	80	110	3700	L274 x W32 x H238	30000	Aluminum housing with tempered glass
FFL72300v0	150	12750 [3000K] 13500 [4000K]	85 [3000K] 90 [4000K]	3000K / 4000K	80	110	5500	L329 x W33 x H290	30000	Aluminum housing with tempered glass
FFL72400v0	200	17000 [3000K] 18000 [4000K]	85 [3000K] 90 [4000K]	3000K / 4000K	80	110	7400	L381 x W40 x H324	30000	Aluminum housing with tempered glass

* Open wire version : 0.5m H05RN-F 3G1.0mm² cable

FFL72200v0

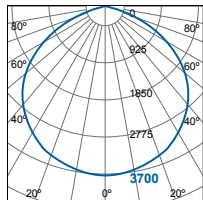

m	Lux	Ø cm
0.5	14800	143
1	3700	286
1.5	1644	428
2	925	571

Beam angle = 110°

FFL72400v0

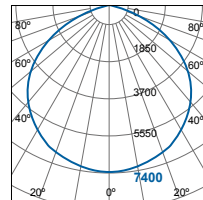

m	Lux	Ø cm
0.5	29600	143
1	7400	286
1.5	3289	428
2	1850	571

Beam angle = 110°

FFL72300v0

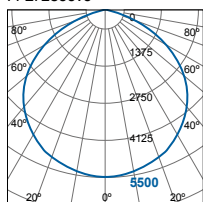

m	Lux	Ø cm
0.5	22000	143
1	5500	286
1.5	2444	428
2	1375	571

Beam angle = 110°

MEGAMAN® VOSS

FFL71800v0-ps

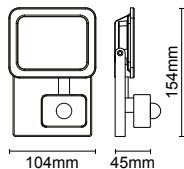

FFL71900v0-ps

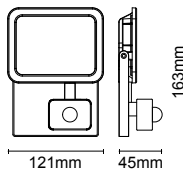

FFL72000v0-ps

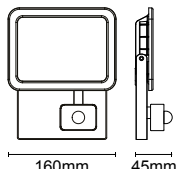
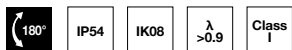

FFL72100v0-ps

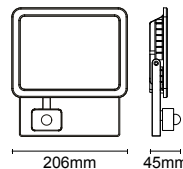

220-240V

Black (BK13)

Model No.	Wattage (W)	Luminous Flux (lm)	Lm/W	Colour Temp.	CRI	Beam Angle(°)	Max. Luminous Intensity (cd)	Dimension (mm)	Rated Life at L70 B50 at Ta25°C (hrs)	Materials
FFL71800v0-ps	11	850 [3000K] 900 [4000K]	77 [3000K] 82 [4000K]	3000K / 4000K	80	110	400	L104 x W45 x H154	30000	Aluminum housing with tempered glass
FFL71900v0-ps	21	1700 [3000K] 1800 [4000K]	81 [3000K] 86 [4000K]	3000K / 4000K	80	110	750	L121 x W45 x H163	30000	Aluminum housing with tempered glass
FFL72000v0-ps	31	2550 [3000K] 2700 [4000K]	82 [3000K] 87 [4000K]	3000K / 4000K	80	110	1100	L160 x W45 x H196	30000	Aluminum housing with tempered glass
FFL72100v0-ps	51	4250 [3000K] 4500 [4000K]	83 [3000K] 88 [4000K]	3000K / 4000K	80	110	1800	L206 x W45 x H230	30000	Aluminum housing with tempered glass

* Open wire version : 0.5m H05RN-F 3G1.0mm² cable

FFL71800v0-ps

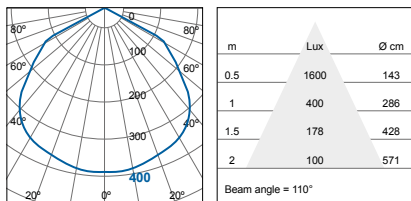

FFL72000v0-ps

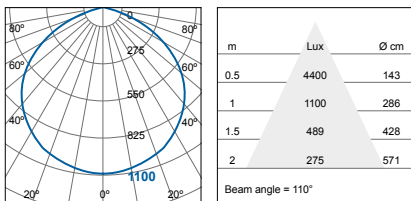

FFL71900v0-ps

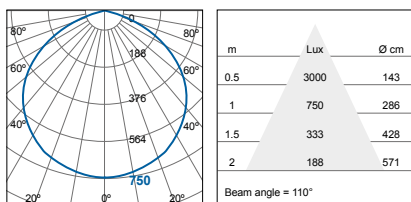

FFL72100v0-ps

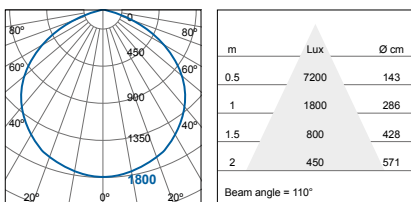

Outdoor Lighting / Floodlight
MEGAMAN® VOSS

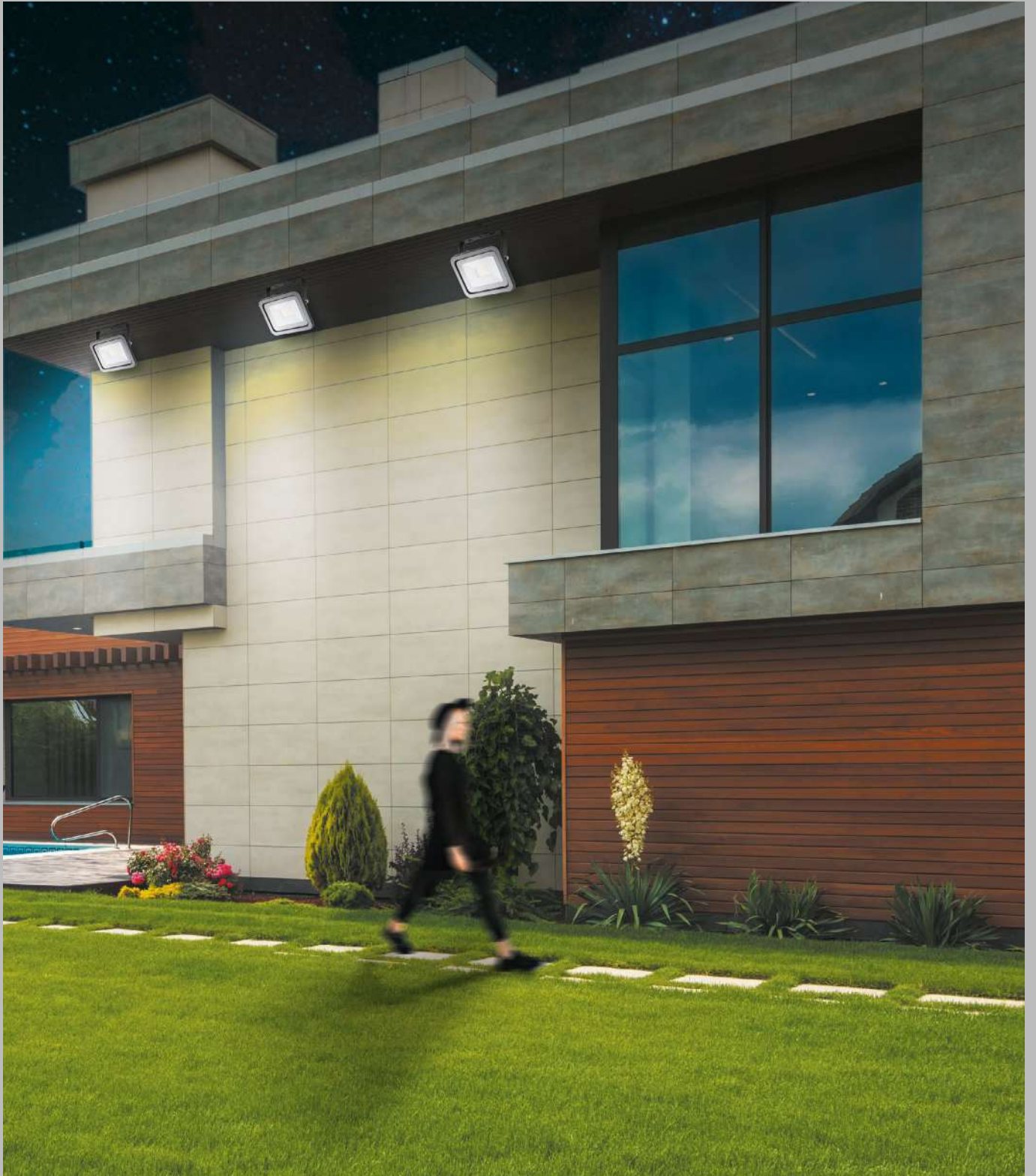

MEGAMAN® FONDA Xchange



NEW



MEGAMAN® FONDA Xchange



MEGAMAN® FONDA Xchange

Modular LED Outdoor Bulkhead

MEGAMAN® FONDA Xchange is an ECO-designed bulkhead with convenience and flexibility with its plug-and-play modular structure of microwave motion sensor and emergency modules. MEGAMAN® FONDA Xchange design concept encompasses the ability to replace both the light source and the control gear to maximize products lifetime and reduce waste. The innovation cross-platform feature of MEGAMAN® FONDA Xchange enables interchangeability between different light sources and control gear.

Features

- Eco-design with replaceable light source and control gear
- Tri-lumen output and Dual CCT switchable
- IP66 waterproof protection and with IK10 rated vandal resistant
- Corrosion free tough polycarbonate enclosure & UV resistant
- High operating temperature of up to 50°C allows use in outdoor environments under extreme weather
- Theft-proof screws are applied for deterring thieves and vandals
- Emergency kit with 300lm output energy backup lasting for 3 hours
- MEGAMAN® FONDA Xchange with microwave motion sensor can serve as a master device to control other FONDA Xchange without sensor as slaves in a group with loop through wiring connection, with maximum 250W loading



Applications

- Car parks
- Warehouses
- Stairwells
- Corridor

MEGAMAN® FONDA Xchange

MEGAMAN® FONDA Xchange

Modular LED Outdoor Bulkhead



For ceiling mounted, microwave sensor can sense movement within around 5m radius horizontally, or 6-7m vertically beneath FONDA Xchange, and only lights up when movement sensed for energy saving.

For wall mounted, microwave sensor can sense movement within around 3-4m radius vertically, or 9m front-facing horizontally, and only lights up when movement sensed for energy saving.

Maximum Connection for microwave motion sensor master-slave looping for 10W is 25 pcs; for 15W is 20pcs; for 22W is 10pcs

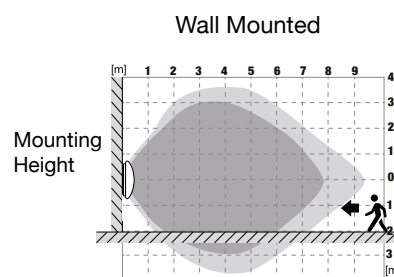
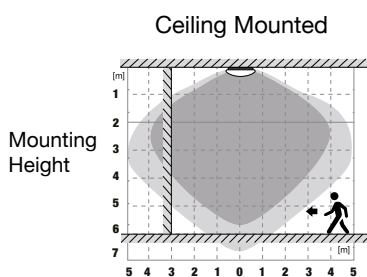

MEGAMAN® FONDA Xchange

FBH71500v0-ds/sc



- IP66
- IK10
- Class II
- $\lambda > 0.9$
- Flicker Free

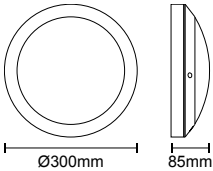

FBH71500v0-ds/sc+
LA10175



- IP66
- IK10
- Class II
- $\lambda > 0.9$
- Flicker Free

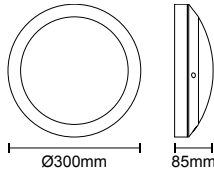

FBH71500v0-ds/sc
+LA11157



- IP66
- IK10
- Class II
- $\lambda > 0.9$
- Flicker Free

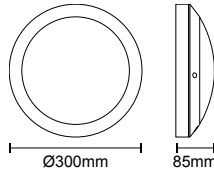

FBH71500v0-ds/sc
+LA10175+LA11157



- IP66
- IK10
- Class II
- $\lambda > 0.9$
- Flicker Free

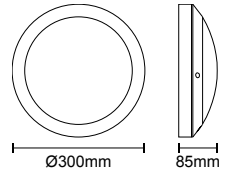

220-240V

White (WH12)

Model No.	Wattage (W)	Luminous Flux (lm)	Luminous Efficacy (lm/W)	Colour Temp.	CRI	Dimension (mm)	Rated Life at L70 B50 at Ta25°C (hrs)	Materials
FBH71500v0-ds/sc	20/15/10W	2000/1500/1000 [4000K] 1860/1400/930 [3000K]	100 [4000K] 93 [3000]	3000K / 4000K	≥80	Ø300 x H85	50000	Polycarbonate
FBH71500v0-ds/sc+LA10175	21/16/11W	2000/1500/1000 [4000K] 1860/1400/930 [3000K]	95 [4000K] 88 [3000]	3000K / 4000K	≥80	Ø300 x H85	50000	Polycarbonate
FBH71500v0-ds/sc+LA11157	23/18/13	2000/1500/1000 [4000K] 1860/1400/930 [3000K]	87 [4000K] 81 [3000]	3000K / 4000K	≥80	Ø300 x H85	50000	Polycarbonate
FBH71500v0-ds/sc+LA10175+LA11157	24/19/14	2000/1500/1000 [4000K] 1860/1400/930 [3000K]	83 [4000K] 78 [3000]	3000K / 4000K	≥80	Ø300 x H85	50000	Polycarbonate

FBH71500v0-ds/sc (20W)

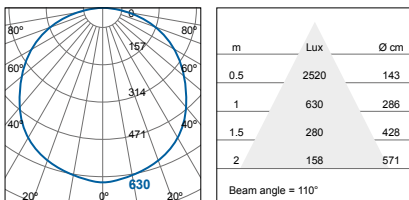

FBH71500v0-ds/sc (15W)

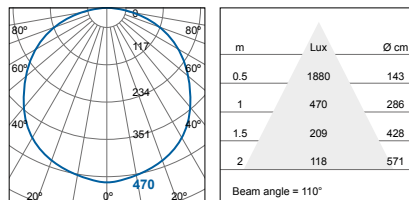

FBH71500v0-ds/sc (10W)

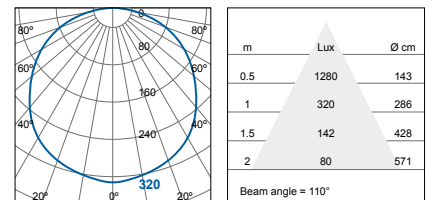

Accessory



LA10175
Microwave Motion
Sensor



LA11157
Emergency Kit
Module

LED Oval Bulkhead

MEGAMAN® ODI



LED Oval Bulkhead MEGAMAN® ODI



MEGAMAN® ODI

LED Oval Bulkhead

The surface mounted MEGAMAN® ODI with strong polycarbonate diffuser and housing is an ideal corrosion free luminaire for outdoor use. Knockout in all directions, with the option of ON/OFF and microwave motion sensor version, together with the sliding switch for adjusting Dual Lumen Output cater different installations and market demands.

Features

- High competitive value-for-money waterproof bulkhead, an ideal direct replacement of traditional incandescent A60 bulkhead in wholesaler or DIY channel
- Dual-lumen output (450/700lm) in the same housing with optional microwave motion sensor module to cater different applications
- Plug-And-Play modular design enhance the installation flexibility
- Easy and fast installation with quick connector
- Diffuser can be attached with snap-in fastening
- IP54 waterproof protection and IK08 rated vandal resistant
- Flicker free
- UV resistant for full outdoor application
- Uniform light distribution without dark zone or hotspot
- Available for wall or ceiling mounted on solid surfaces such as concrete or brick
- Flexible installation with cable entries in all directions with 2 grommet included
- Fully corrosion free housing
- DC input compatible (180-260VDC)



Applications

- Car parks
- Public area
- Stairwells
- Corridors
- Garden and balcony

Accessories



LA10200
Microwave motion
sensor module

LED Oval Bulkhead

MEGAMAN® ODI

FBH70100v0-ds
FOB70100v0-ds/ms

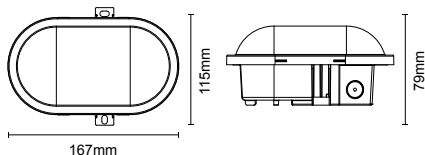

220-240V

Silver (SV12)

Model No.	Wattage (W)	Luminous Flux (lm)	Luminous Efficacy (lm/W)	Dimension (mm)	Colour Temp. (CRI)	Rated Life @ L70B50 @Ta25°C (hrs)	Materials
FBH70100v0-ds	4.5 / 7.5	3000K - 420lm (LO) / 660lm (HO) 4000K - 450lm (LO) / 700lm (HO)	3000K - 93lm/W(LO) / 88lm/W(HO) 4000K - 100lm/W(LO) / 93lm/W(HO)	L167 x W115 x H79	3000K / 4000K	25000	Polycarbonate cover & housing
FOB70100v0-ds/ms	5.5 / 8.5	3000K - 420lm (LO) / 660lm (HO) 4000K - 450lm (LO) / 700lm (HO)	3000K - 78lm/W(LO) / 76lm/W(HO) 4000K - 82lm/W(LO) / 82lm/W(HO)	L167 x W115 x H79	3000K / 4000K	25000	Polycarbonate cover & housing

FOB70100v0-ds

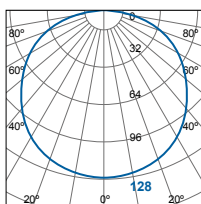

m	Lux	Ø cm
0.5	512	173
1	128	346
1.5	57	520
2	32	693

Beam angle = 120°

FOB70100v0-ds/ms

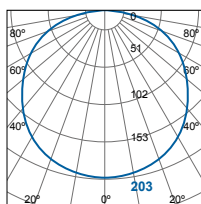

m	Lux	Ø cm
0.5	812	173
1	203	346
1.5	90	520
2	51	693

Beam angle = 120°

Functional installation features

Sliding Switch for adjusting the low output / high output

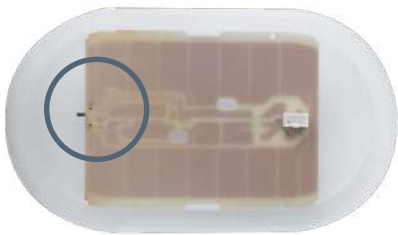

Easy & fast installation with quick connector



Knockout in all directions (top / bottom / 2 sides / back)



MEGAMAN® CODY





MEGAMAN® CODY

Outdoor Bulkhead

MEGAMAN® CODY is a cost-effective bulkhead available in both oval and round options. It is constructed with corrosion free plastic housing and with UV resistant opal diffuser, together IP65 waterproof protection structure. An effective LED replacement for conventional outdoor bulkhead.

Features

- Compact and Ultra Slim Outdoor Bulkhead
- Cost effective LED Outdoor Bulkhead solution for mains voltage with good system light yield for energy-saving operation
- IP65 waterproof protection and IK08 for vandal resistance
- Corrosion free with plastic housing and UV resistant opal diffuser
- Homogeneous light output
- Oval and round options available
- Wide range of sizes allow retrofit for traditional outdoor bulkhead
- Simple and neat screw-less design

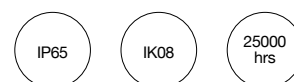

Applications

- Stairwells
- Corridors
- Patios

MEGAMAN® CODY

FBH70500v0

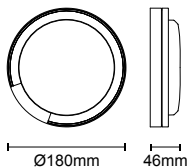

FBH70600v0

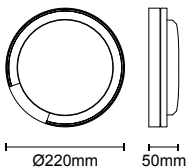

FBH70700v0

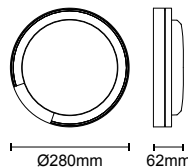

220-240V

White (WH12) Black (BK12)

Model No.	Wattage (W)	Luminous Flux (lm)	Luminous Efficacy (lm/W)	Colour Temp.	CRI	Dimension (mm)	Rated Life at L70 B50 at Ta25°C (hrs)	Materials
FBH70500v0	15	1080 [3000K] 1200 [4000K / 6500K]	72 [3000K] 80 [4000K / 6500K]	3000K / 4000K / 6500K	≥80	Ø180 x H46	25000	Plastic housing + Opal Diffuser
FBH70600v0	20	1140 [3000K] 1600 [4000K / 6500K]	57 [3000K] 80 [4000K / 6500K]	3000K / 4000K / 6500K	≥80	Ø220 x H50	25000	Plastic housing + Opal Diffuser
FBH70700v0	24	1800 [3000K] 2000 [4000K / 6500K]	75 [3000K] 83 [4000K / 6500K]	3000K / 4000K / 6500K	≥80	Ø280 x H62	25000	Plastic housing + Opal Diffuser

Outdoor Lighting / Bulkhead
MEGAMAN® CODY

FBH70800v0

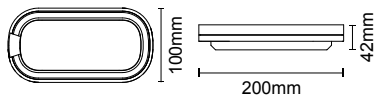

FBH70900v0

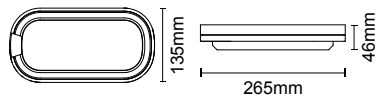

220-240V



Model No.	Wattage (W)	Luminous Flux (lm)	Luminous Efficacy (lm/W)	Colour Temp.	CRI	Dimension (mm)	Rated Life at L70 B50 at Ta25°C (hrs)	Materials
FBH70800v0	12	900 [3000K] 960 [4000K / 6500K]	75 [3000K] 80 [4000K / 6500K]	3000K / 4000K / 6500K	≥80	W100 x L200 x H42	25000	Opal Housing + Plastic Diffuser
FBH70900v0	20	1340 [3000K] 1440 [4000K / 6500K]	67 [3000K] 72 [4000K / 6500K]	3000K / 4000K / 6500K	≥80	W135 x L265 x H46	25000	Opal Housing + Plastic Diffuser

MEGAMAN® RONDA



MEGAMAN® RONDA



MEGAMAN® RONDA

Outdoor Integrated LED Bulkhead

MEGAMAN® RONDA is a round shaped LED bulkhead perfectly for outdoor lighting. It is constructed with corrosion free plastic housing and UV resistant opal diffuser, together with IP65 waterproof protection structure. With additional optional features of built in microwave sensor for energy saving.

Features

- Cost effective LED outdoor bulkhead solution for mains voltage with good system yield
- Built in microwave sensor option for energy saving operation
- IP65 protection and high vandal resistant with IK08
- Homogeneous light output
- Loop through structure
- Compatible to mount in UK Beza box

Accessory

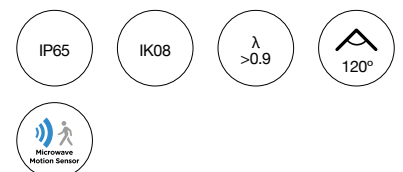

Applications

- Car parks
- Warehouses
- Stairwells
- Corridors

MEGAMAN® RONDA

FBH71300v0
FBH71300v1

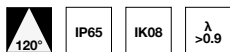

FBH71300v0-ms
FBH71300v1-ms

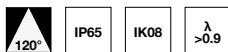



220-240V

White (WH12)

Standard Version

Model No.	Wattage (W)	Luminous Flux (lm)	Efficiency (lm/W)	Colour Temp. (CRI)	Beam Angle (°)	Dimension (mm)	Rated Life @L70B50 @ Ta25°C (hrs)	Materials
FBH71300v0	12	1100	92	4000K [≥80]	120	Ø250 x H100	30000	PC housing + PC diffuser
FBH71300v1	14	1300	92	4000K [≥80]	120	Ø250 x H100	30000	PC housing + PC diffuser

Motion Sensor version

Model No.	Wattage (W)	Luminous Flux (lm)	Efficiency (lm/W)	Colour Temp. (CRI)	Beam Angle (°)	Dimension (mm)	Rated Life @L70B50 @ Ta25°C (hrs)	Materials
FBH71300v0-ms 	13	1100	85	4000K [≥80]	120	Ø250 x H100	30000	PC housing + PC diffuser
FBH71300v1-ms 	15	1300	87	4000K [≥80]	120	Ø250 x H100	30000	PC housing + PC diffuser

FBH71300v0

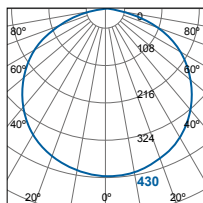

m	Lux	Ø cm
0.5	1720	173
1	430	346
1.5	191	520
2	108	693

Beam angle = 120°

FBH71300v1

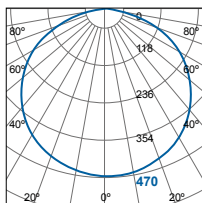

m	Lux	Ø cm
0.5	1880	173
1	470	346
1.5	209	520
2	118	693

Beam angle = 120°

MEGAMAN® RONDA

FBH71400v0
FBH71400v1

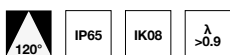

FBH71400v0-ms
FBH71400v1-ms

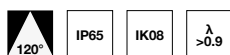



220-240V

White (WH12)

Standard Version

Model No.	Wattage (W)	Luminous Flux (lm)	Efficiency (lm/W)	Colour Temp. (CRI)	Beam Angle (°)	Dimension (mm)	Rated Life @L70B50 @ Ta25°C (hrs)	Materials
FBH71400v0	18	1650	92	4000K [≥80]	120	Ø300 x H100	30000	PC housing + PC diffuser
FBH71400v1	24	2200	92	4000K [≥80]	120	Ø300 x H100	30000	PC housing + PC diffuser

Motion Sensor version

Model No.	Wattage (W)	Luminous Flux (lm)	Efficiency (lm/W)	Colour Temp. (CRI)	Beam Angle (°)	Dimension (mm)	Rated Life @L70B50 @ Ta25°C (hrs)	Materials
FBH71400v0-ms 	19	1650	87	4000K [≥80]	120	Ø300 x H100	30000	PC housing + PC diffuser
FBH71400v1-ms 	25	2200	88	4000K [≥80]	120	Ø300 x H100	30000	PC housing + PC diffuser

FBH71400v0

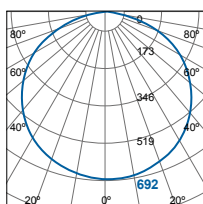

m	Lux	Ø cm
0.5	2768	173
1	692	346
1.5	308	520
2	173	693

Beam angle = 120°

FBH71400v1

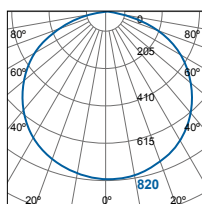

m	Lux	Ø cm
0.5	3280	173
1	820	346
1.5	364	520
2	205	693

Beam angle = 120°



MEGAMAN® TEKA

Garden Lighting

Designed for outdoor application, MEGAMAN® TEKA features IP66 protection with rust-free finishing for a spike-mounted solution. MEGAMAN® TEKA is an integrated LED spike-mounted luminaire with built-in driver, it is perfect to replace conventional spike-mounted luminaires.

MEGAMAN® TEKA offers a flexible 180° tilt angle for directional lighting. It is made of an extra lightweight and durable polycarbonate material, it offers visual comfort with minimal glare.

Features

- Integrated LED with built-in driver which facilitates easy installation and maintenance
- Flexible tilt angle of 180° for directional lighting
- Offers visual comfort with minimal glare
- With IP66 protection, perfect for outdoor application
- Glare shield and spike are available for different applications
- Made with extra light-weight and durable polycarbonate material
- Rust-free finish

Applications

- Gardens
 - Driveways
 - Small lanes
-

Outdoor Lighting / Garden Lighting

MEGAMAN® TEKA

F03500SP

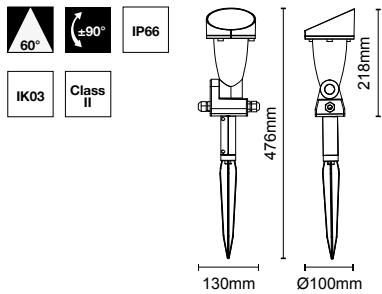

220-240V



Model No.	Wattage (W)	Luminous Flux (lm)	Luminous Efficacy (lm/W)	Beam Angle (°)	Max. Luminous Intensity (cd)	Dimension (mm)	Colour Temp. [CRI]	Rated Life (hrs)	Materials
F03500SP	10.5	700	67	60	520	W100 x L130 x H476	3000K / 4000K [Ra80]	25000	Polypropylene compound

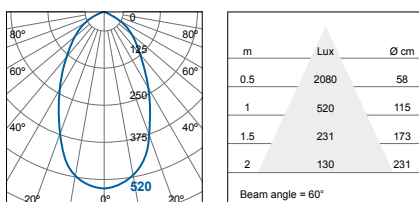

Complete set comes with



Luminaire

Glare Shield

Spike



MEGAMAN® CAPPI

Garden Lighting

MEGAMAN® CAPPI is a spike-mounted luminaire with IP54 protection for outdoor use. Working with the MEGAMAN® water-resistant LED PAR38 reflector lamp, MEGAMAN® CAPPI delivers excellent light output, which is perfect for use in gardens, driveways and small lanes. It offers a flexible tilt angle of 120° for directional lighting. It is made of an extra lightweight and durable polypropylene material.

Features

- Directly connects to the mains, which means it is free of compatibility issues with no extra cost for an external driver
- Reduces installation time and space required
- IP54 protection for outdoor use
- Instant start

Applications

- Gardens
 - Driveways
 - Small lanes
-

Outdoor Lighting / Garden Lighting
MEGAMAN® CAPPI

F32114SP

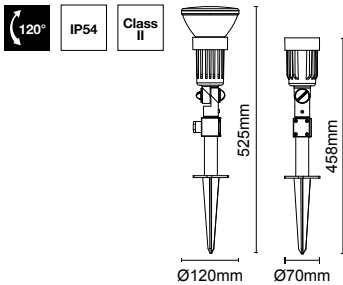

Black (BK12)

Model No.	Max. Wattage (W)	Dimension (mm)	Light Source	Lamp Base	Materials
F32114SP	16	Ø70 x H458	LED PAR38	E27	Polypropylene compound

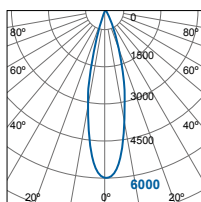
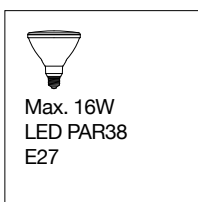

m	Lux	Ø cm
0.5	24000	22
1	6000	44
1.5	2667	67
2	1500	89

Beam angle = 25°

Decoding the MEGAMAN® Model Number

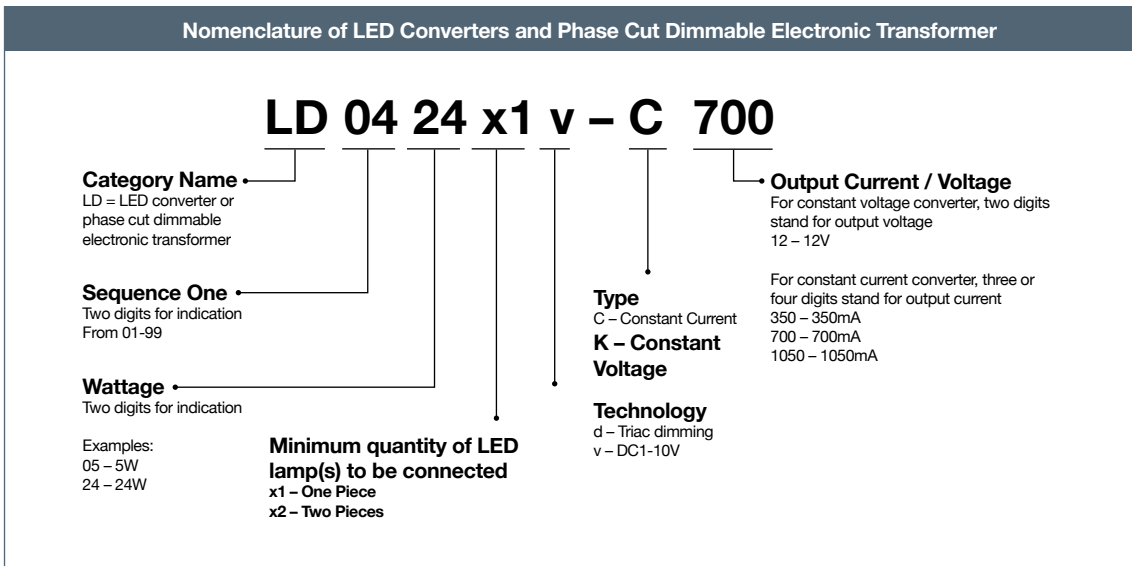
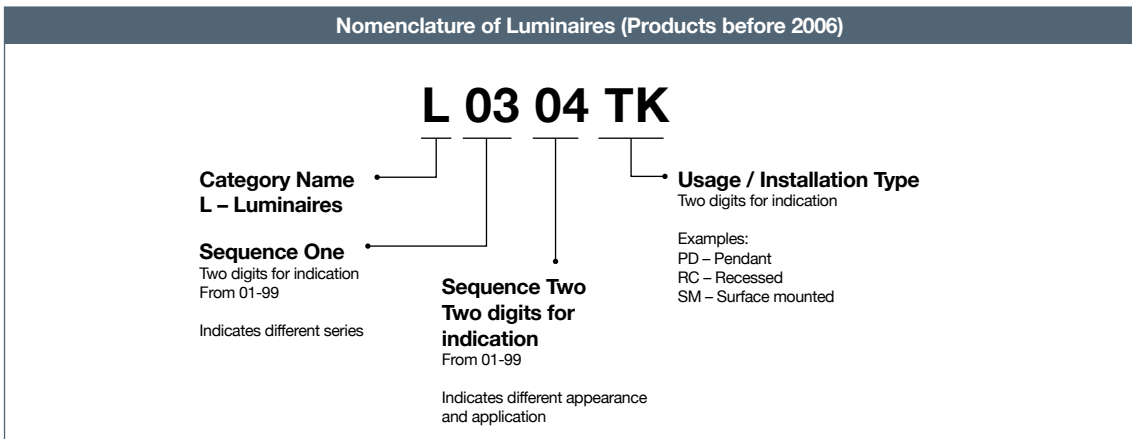
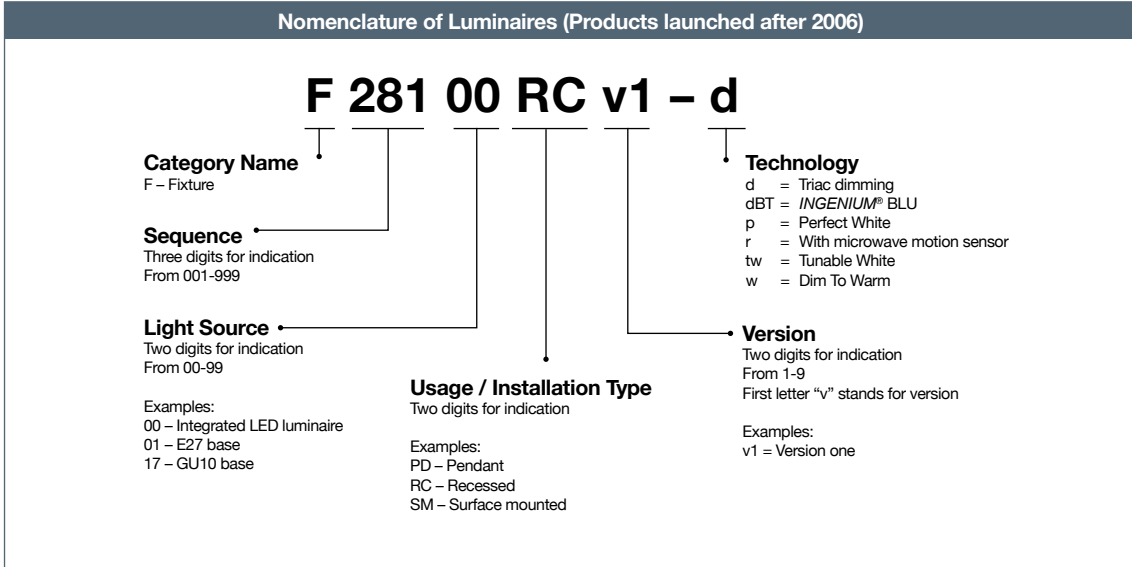

Upgrade of Nomenclature System

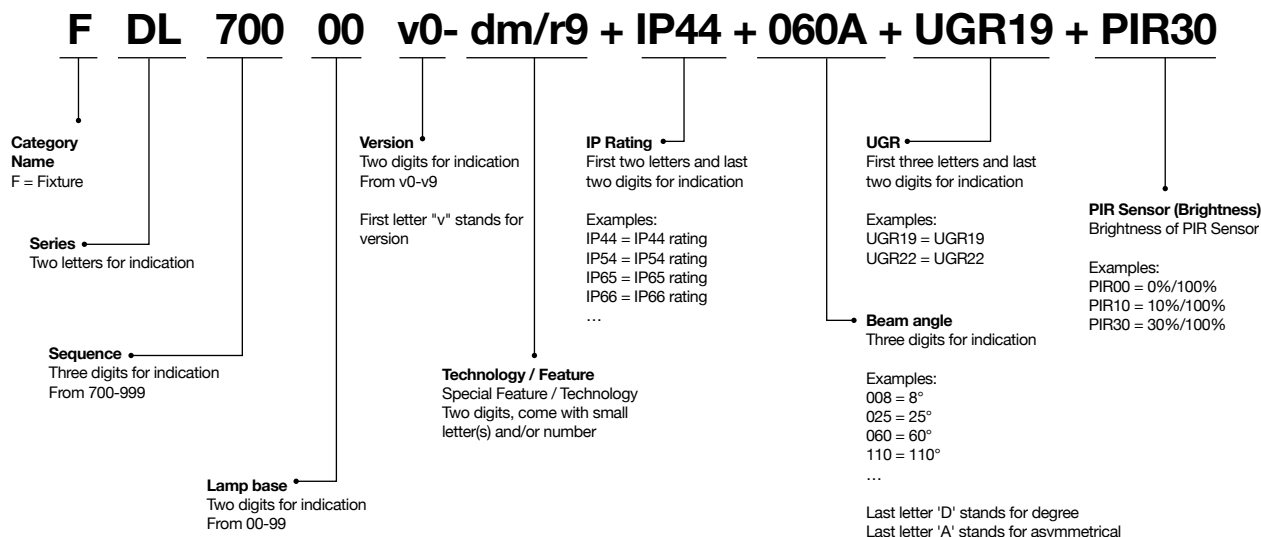

Series
Two letters for indication

Example:

Proposed Prefix	Series
GB	Gimbal
LB	Lowbay
HB	Highbay
GL	Garden Lamp
DS	Downlight (≤ Ø95mm)
DM	Downlight (>Ø95mm to ≤Ø140mm)
DL	Downlight (>Ø140mm)
IB	Indoor Batten
OB	Outdoor Batten
TA	Tracklight (Asian track, 1-way)
TK	Tracklight (European track, 3 way)
TJ	Tracklight (Japanese track)
FL	Floodlight
PL	Panel
LP	Linear Profile
CL	Indoor Ceiling Lamp
BH	Outdoor Bulkhead
WL	Wall Lamp
BA	Bollards
IG	In-ground
WK	Working Lamp
PD	Pendant Lamp

Lamp base
Two digits for indication (From 00-99)

Example:

00	Integrated LED luminaire
01	General E27 Type
02	General E14 Type
03	General B22 Type
04	General B15d Type
05	General E12 Type
06	General E17 Type
07	General E26 Type
08	General E26/E25 Type
09	General E40 Type
11	Reflector / lamp with R50 Shape
12	Reflector / lamp with R63 Shape
13	Reflector / lamp with R80 Shape
14	Reflector with PAR38 Shape
15	Reflector with PAR30 Shape
17	Reflector with GU10 Shape
18	Reflector / lamp with GX53 Shape
33	Plug-In with R7s Base
35	Reflector with PAR20 Shape
39	Connector for lamp with G53 Base
40	Reflector with GX8.5 Shape
41	Plug-In with MR16 Base
42	Reflector with E14 Base
43	LED Module TECOH® MHx in 24W
45	LED Light Engine TECOH® CFx PHJ65-2
46	LED R7s with 78mm length
47	LED R7s with 118mm length
48	LED Module TECOH® MHx in 17W
49	LED Module TECOH® RDx
51	LED Light Engine TECOH® Thx
52	Asian track (1-way)
53	European track (3-way)
54	Japanese track compatible (1-way)

Technology / Feature
Special Feature / Technology
Two digits, come with small letter(s) and/or number
Example:

Existing Suffix	Proposed Suffix	Special Feature / Technology
Product with <i>INGENIUM</i> ® BLU technology, start with 'b'		
-dBT	-b1	<i>INGENIUM</i> ® BLU Gen 1
-dBT2	-b2	<i>INGENIUM</i> ® BLU Gen 2
Product with <i>INGENIUM</i> ® ZB technology, start with 'z'		
-dZB	-zb	<i>INGENIUM</i> ® ZB 3.0
Others		
-d	-dm	Phase-Cut Dimming (Compact Dim, Dimmerable, U-DIM)
-	-da	built-in DALI Dimming
-	-db	Dual Beam Technology™
-	-dc	built-in DC1-10V Dimming
-w	-dw	Dim to Warm
-s	-ds	Step Dimming
-r	-ms	with Microwave Motion Sensor
-	-ps	with PIR Sensor
-p	-pw	Perfect White
-R9	-r9	RichColour
-	-ru	Ultra RichColour
-tw	-tw	Tunable White
-	-ex	External Driver Required
-	-em	Emergency Option
-	-hs	High Saturation
H	-hp	High Power Factor
-	-pl	Permanent Live for Emergency
-	-sc	Switching Correlated Colour Temperature (CCT)
-	-sw	ON/OFF Switch

Colours / Materials

Code			Description (Colour, material, main process, 2nd process/texture, sequence)	Reference RAL Colour and Pantone
BK	1	1	Black, Plastic, Injected, Glossy, #1	RAL9004
BK	1	2	Black, Plastic, Injected, Matt, #2	RAL9004
BK	2	1	Black, Metal, Paint sprayed, Glossy, #1	RAL9005
BK	2	2	Black, Metal, Paint sprayed, Matt, #2	RAL9004
BK	2	3	Black, Metal, Paint sprayed, Coarse matt, #3	
BK	2	4	Black, Metal, Paint sprayed, Matt, #4	
BK	6	1	Black, Metal, Anodizing, Matt brush, #1	RAL9005
CH	5	1	Chromium, Metal, Electroplating, Brush, #1	
CH	5	2	Chromium, Metal, Electroplating, #1	
GD	2	1	Gold, Metal, Paint sprayed, Champagne, #1	RAL1035
GD	2	2	Gold, Plastic, Paint sprayed, Champagne, #2	
GD	2	3	Gold, Metal, Paint sprayed, Coarse Matt, #3	
GD	3	1	Gold, Plastic, Hot stamping, Brush, #1	RAL9006
GD	4	1	Gold, Plastic, Vacuum metalising gold, #1	
GD	5	1	Gold, Plastic, Electroplating, #1	
GD	5	2	Gold, Metal, Electroplating, #2	
GN	1	1	Green, Plastic, Injected, Glossy, #1	RAL6012
GN	1	2	Green, Plastic, Injected, Matt, #2	RAL6012
NI	4	1	Nickel, Plastic, Vacuum metalising aluminium, #1	
NI	5	1	Nickel, Plastic, Electroplating, #1	
NI	5	2	Nickel, Plastic, Electroplating, Swirl brush, #2	
NI	5	3	Nickel, Metal, Electroplating, Swirl brush, #3	
SV	1	1	Silver-grey, Plastic, Injected, Glossy, #1	RAL7005
SV	1	2	Silver-grey, Plastic, Injected, Matt, #2	RAL7036
SV	1	3	Silver-grey, Plastic, Injected, Matt, #3	
SV	1	4	Silver-grey, Plastic, Injected, Matt, #4	RAL7047
SV	1	5	Silver-grey, Plastic, Injected, Glossy, #5	RAL7042
SV	1	6	Silver-grey, Plastic, Injected, Matt, #6	
SV	2	1	Silver-grey, Plastic, Paint sprayed, Glossy, #1	RAL7040
SV	2	2	Silver-grey, Plastic, Paint sprayed, Matt, #2	RAL9006
SV	2	3	Silver-grey, Metal, Paint sprayed, Glossy, #3	RAL7038
SV	2	4	Silver-grey, Metal, Paint sprayed, Matt, #4	RAL9006
SV	2	5	Silver-grey, Plastic, Paint sprayed, Glossy, #5	RAL9006
SV	2	6	Silver-grey, Metal, Paint sprayed, Glossy, #6	RAL9006
SV	2	7	Grey, Metal, Paint sprayed, Granite, #7	
SV	2	8	Silver-grey, Metal, Paint sprayed, Glossy, #8	
SV	3	1	Silver-grey, Plastic, Hot stamping, Brush, #1	
SV	6	1	Silver-grey, Metal, Anodizing, Straight brush, #1	RAL9006
SV	6	2	Silver-grey, Metal, Anodizing, Sandblast, #2	RAL9006
SV	6	3	Silver-grey, Metal, Sandblast, #1	
SV	6	4	Silver-grey, Metal, Anodizing, Swirl brush, #4	
WH	1	1	White, Plastic, Injected, Glossy, #1	RAL9001
WH	1	2	White, Plastic, Injected, Matt, #2	RAL9001
WH	1	3	White, Plastic, Injected, Glossy, #3	RAL9003
WH	2	1	White, Metal, Paint sprayed, Glossy, #1	RAL9003
WH	2	2	White, Metal, Paint sprayed, Granite, #2	
WH	2	3	White, Plastic, Paint sprayed, Glossy, #3	
WH	2	4	White, Metal, Paint sprayed, Coarse matt, #4	
WH	2	5	Ivory White, Metal, Paint sprayed, Matt, #5	
WH	2	6	White, Metal, Paint sprayed, Matt, #6	

Connection Box / Terminal Block

Model No.	Connection type		
LA2501	Parallel type (Short version)	2-Way	
LA2502	Single screw type (Long version)	2-Way	
LA2504	Single screw type (Short version)	2-Way	
LA2505	Parallel type (Long version)	2-Way	
LA5111	Single screw type	3-Way	
LA5113	Single/Parallel push-in type	3-Way	
LA5211 (with fixing bracket)	Single screw type	3-Way	
LA5213 (with fixing bracket)	Single/Parallel push-in type	3-Way	

Symbol Information

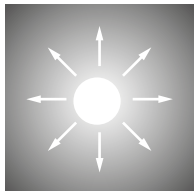

Luminous Flux

Unit: lumen

Luminous flux is the total amount of light energy radiated from a light source in all directions and is expressed in lumens.

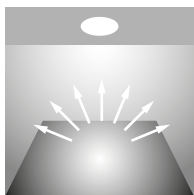

Luminous Intensity

Unit: candela (cd)

Luminous intensity is the luminous flux in a given direction expressed in candelas (cd) as a measure of the visibility of a light source.

Most light sources emit the light at different strengths in different directions, the intensity distribution must be given for all directions to have a complete description of the light field. The representation in a polar-coordinate diagram is called a luminous intensity distribution curve.

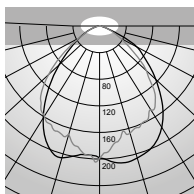

Luminous Intensity Distribution Curve

A luminous intensity distribution curve is a graphical presentation of the distribution of light intensity of a light source, mainly used to show the light output of a reflector lamp or a luminaire. The curve is typically represented in polar plots because this format helps users to visualize both the orientation and the light distribution of the luminaire.

The luminous intensity distribution of a luminaire depends on its optical design that can involve the shape and form of the light source, reflectors, louvres, diffusers, lenses or shields which may be used to control the light output.

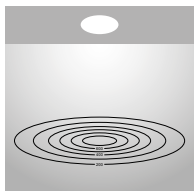

Illuminance

Unit: lx

Illuminance is the quantity of light illuminating a surface from all directions. Standard unit of measurement is lux (lx), which is lumen per square meter (lm/m²).

This is used to measure the brightness level of a working surface or an area. The illumination level is often represented with isolux-curves.

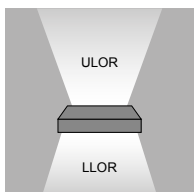

Light Output Ratio (LOR)

The ratio of the total light emitted by a luminaire to the total light output of the lamp(s) fitted into the luminaire. The light output ratio is always less than 1.

It is sometimes divided into an Upper Light Output Ratio (ULOR) and a Lower Light Output Ratio (LLOR).

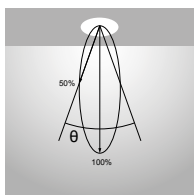



Beam Angle (θ)

Unit: °



The beam angle defines the angular dimension of the light cone from directional lamps, it is measured between the points in the beam that are 50% of the centre peak intensity. It is an important parameter reference for spotlights and reflector lamps.

Explanation of IP Numbers for Degrees of Protection

Degrees of protection indicated by the first characteristic numeral

First characteristic numeral	Degree of protection	
	Short description	Brief details of objects which will be "excluded" from the enclosure
2	Protected against solid objects greater than 12mm	Fingers or similar objects not exceeding 80mm in length. Solid objects exceeding 12mm in diameter
4	Protected against solid objects greater than 1,0mm	Wires or strips of thickness greater than 1,0mm. Solid objects exceeding 1,0mm in diameter
5	 Dust-protected	Ingress of dust is not totally prevented but dust does not enter in sufficient quantity to interfere with satisfactory operation of the equipment
6	 Dust-tight	No ingress of dust

Degrees of protection indicated by the second characteristic numeral

Second characteristic numeral	Degree of protection	
	Short description	Details of the type of protection provided by the enclosure
0	Non-protected	No special protection
3	 Protected against spraying water	Water falling as a spray at an angle up to 60° from the vertical shall have no harmful effect
4	 Protected against splashing water	Water splashed against the enclosure from any direction shall have no harmful effect
5	 Protected against water jets	Water projected by a nozzle against the enclosure from any direction shall have no harmful effect
6	Protected against heavy seas	Water from heavy seas or water projected in powerful jets shall not enter the enclosure in harmful quantities



Class I - Earthed
Protection against electrical shock by earthing



Class II - Double Insulated
The luminaire provides protection against electrical shock using both the base insulation and an additional or reinforced insulation.



Class III - SELV
Supply by safety extra-low voltage provides protection against electrical shock.



European Community Mark

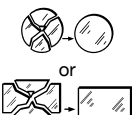

Replace any cracked protective shield



Beam angle



Rotating angle



Tilting angle

Chemical Resistance

Chemical Agents	Polycarbonate	PMMA	Stainless Steel
Acetic acid 10%	+	+	+
Acetone	-	-	+
Alcoholic beverages	+	0	+
Aluminium sulphate	+	+	0
Ammonia 5%	-	+	+
Aniline	-	-	+
Arsenic acid 20%	+	+	+
Benzene	-	-	0
Bencylic alcohol	-	-	0
Bromine	-	-	-
Calcium Chloride	+	+	0
Calcium nitrate	+	+	0
Carbon tetrachloride	-	-	0
Carbonic acid	-	-	+
Caustic potash 5%	-	+	0
Cement	+	+	0
Hydrochloric acid 1-5%	+	+	-
Chlorine liquids (vapours)	-	-	0
Chloroform	-	-	+
Chromic acid	0	0	0
Citric acid 20%	+	+	0
Copper sulphate	+	+	0
Diesel-naphta oil	0	+	+
Ethyl alcohol 30%	+	0	+
Ethyl chloride	-	-	+
Ethyl ether	-	-	0
food oils and fats	-	+	+
formic acid 10%	+	+	0
Glycerine	+	+	+
Hexane	+	+	+
Iodine	-	+	-
Iron chloride	+	+	-
Isopropylic alcohol	0	0	0
Lubricating oil	+	+	+
Magnesium sulphate	+	+	+
Methanol	-	0	+
Mineral oils	+	+	+
Nitric acid 20%	0	+	+

Chemical Resistance

Chemical Agents	Polycarbonate	PMMA	Strainless Steel
Oxygen	+	+	+
Ozone	+	+	o
Perchloric acid 10%	+	+	-
Petrol	-	+	+
Phenol	-	-	o
Potassium bromide	+	+	o
Potassium nitrate	+	+	o
Potassium permanganate	+	+	o
Sea climate	+	+	o
Silicon oils	+	o	+
Soda bleach 15%	-	+	o
Sodium chloride	+	+	o
Sodium hydroxide 5%	-	+	o
Sodium sulphate	+	+	o
Sugar	+	+	+
Sulphur	+	+	o
Sulphuric acid 30%	+	+	-
Toluene	-	-	+
Trichloroethylene	-	-	o
Zinc sulphate	+	+	o

+	Resistant
o	Relatively resistant
-	Non-resistant



Unit 1907, 19/F, Lu Plaza,
2 Wing Yip Street, Kwun Tong, Kowloon, Hong Kong
Tel: (852) 2305 1722
Fax: (852) 2758 5957
Email: info@megaman.cc

www.megaman.cc

© Copyright 2024. All rights reserved by MEGAMAN®.
All information stated is correct at the time of printing and subject to changes without prior notice.